

© B/A Products Co.
8925 McGaw Court
Columbia, MD 21045
T: 800.327.3301
F: 410.381.6358

BAPROD.COM

**B/A Products
DISTRIBUTED BY:**

20210930



SBA **PRODUCTS CO.®**

PRODUCTS CATALOG

*Towing
Auto Transport
Fire Rescue*
baprod.com





THE B/A MISSION

'We believe in a world where safety and prosperity can coexist.'

WE CARE ABOUT YOUR SAFETY.

Most accidents, whether they occur at work, at home or on the roadway can be prevented by taking basic safety precautions. A careful and properly trained operator is the best insurance against an accident or injury. There are many nationally recognized trainers and training programs run by local towing associations, tradeshow and organizations. Please contact these organizations directly and follow B/A on social media to learn more.

Most of the products manufactured or distributed by B/A Products Co. are OEM equivalents (often used by the OEM's) or built to specific and recognized industry standards to perform a specific function. These products are to be used in the unique applications for which they were designed. The products offered for sale in this catalog are only to be used in the manner for which they were designed and within the assigned workload limits.

B/A Products Co. assumes those who purchase and use our products have been properly trained and are familiar with the applications for which an individual product was designed. B/A Products Co. assumes no liability for improperly trained operators or the negligent or improper use, intentional or otherwise, of any of the products we manufacture or distribute. If there is any uncertainty as to the proper usage of any product, please do not proceed.

FOR MORE INFORMATION PLEASE VISIT OUR WEBSITE
WWW.BAPROD.COM

To navigate and understand warnings throughout this catalog, please read:



WARNING: PRODUCTS ARE NOT RATED OR APPROVED FOR OVERHEAD LIFTING UNLESS SPECIFIED. Please utilize the various resources listed throughout the catalog and B/A website specs and usage section. Products are rated for overhead lifting will display the below symbol:



RATED FOR OVERHEAD LIFTING

WLL stands for Working Load Limit, the maximum weight that a piece of rigging should ever see (or be loaded to) under normal conditions and is calculated as a ratio of the Minimum Break Strength (MBS).



WARNING: NEVER EXCEED THE WORKING LOAD LIMIT!

Note that on some parts, where the color is not used as a safety factor, the color of the product may vary.

All products are sold as individual pieces unless otherwise specified.

B/A Products takes pride in testing and tagging our rated products. All products will come tagged with a rated working load limit where applicable.



TESTED & TAGGED!

TABLE OF CONTENTS

TOW CHAIN

Grade 70

J Hook & Chain **5**

V-Chains **7**

Assemblies **10**

Hooks **12**

Grade 80

Assemblies & V-Chain **14**

Assemblies & Hooks **15**

Grade 100

Assemblies **16**

Hooks & Fittings **19**

Grade 120

Chain Assemblies **20**

Hooks & Fittings **20**

Bulk Chain **21**

Load Binders **22**

Shackles **23**

Coupling Links **24**

D-Rings **25**

TOW STRAP

Strap Kits **29**

V-Straps **32**

Carrier Straps **35**

Carrier Basket Straps **37**

Wheel Lift Straps **38**

Axle Straps **41**

Underlift Straps **41**

Steering Wheel Straps **42**

Ratchets & Attachments **43**

Round Slings **46**

Recovery & Lifting **48**

Accessories **50**

Cargo Straps **51**

Wreckmaster **52**

TOW WIRE ROPE

Winch Line **55**

Super Swaged **57**

Synthetic Winch Line **58**

Snatch Blocks **59**

Service Parts **61**

Accessories **61**

TOWING ACCESSORIES

Skates **63**

Vehicle Positioning **65**

Motorcycle **66**

Dollies **67**

Safety **71**

Tools & Accessories **72**

Storage **73**

TOW LIGHTING & ELECTRICAL

Lights **75**

Jump Start **77**

AUTO TRANSPORT CHAIN

Assemblies & Hooks **79**

AUTO TRANSPORT STRAPS

Trailer & Ratchet Straps **82**

E-Track & Axle Tie-Downs **85**

Ratchets & Accessories **86**

AUTO TRANSPORT GEAR HEAD & SAFETY LOCKS

Gear Heads & Pawls **88**

Position Safety Locks **89**

Spring Locks & Accessories **90**

AUTO TRANSPORT ELECTRIC & HYDRAULIC

Motors & Pumps **92**

Switches & Accessories **93**

Cylinder Ordering **94**

AUTO TRANSPORT AFTERMARKET PARTS

Fabricated Parts **96**

Ramps & Accessories **97**

AUTO TRANSPORT TRUCK ACCESSORIES

Transport Safety **99**

Door Tools **101**

FIRE & RESCUE

Chain & Hooks **103**

Shackles & Round Slings **105**

Winch Line & Extensions **106**

Snatch Block **106**

SPECS & USAGE

Chain & Hooks **106-112**

HV

G100 & G120 CHAIN

Weather Resistance 
 Overall Strength 
 Visibility 

Approved for Overhead Lifting 



High visibility bright yellow powder coating finish for improved safety and weather resistance. This round link chain is strong and lightweight.

G120

GRADE 120 CHAIN

Weather Resistance 
 Overall Strength 
 Visibility 

Approved for Overhead Lifting 

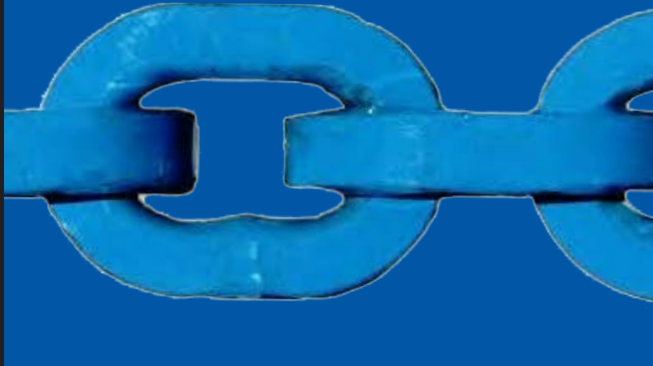

Square link design. Grade 120 Chain has a higher work load limit compared to Grade 80 and Grade 100. Distinctive blue coat finish. Approved For Overhead Lifting.

G100

GRADE 100 CHAIN

Weather Resistance 
 Overall Strength 
 Visibility 



Approved for Overhead Lifting 



Produced from a special alloy steel. Gray protective coating and 25% higher Work Load Limit. Meets NCAM, OSHA and ANSI standards for overhead lifting.

G80

GRADE 80 CHAIN

Weather Resistance 
 Overall Strength 
 Visibility 

Approved for Overhead Lifting 



Produced, generated and designed from alloy steel. Black protective coating. Meets NACM, OSHA and ANSI standards for overhead lifting.

G70

GRADE 70 CHAIN

Weather Resistance 
 Overall Strength 
 Visibility 

NOT Approved for Overhead Lifting! 



Produced from heat-treated carbon steel. Standard for towing, logging and tie-down applications. Yellow Zinc Plated. Meets NACM standards.

TOWING CHAIN

When you are looking to safely and securely tow or recover a vehicle, whether it's a tanker or a small car, you want to make sure you have the best tools at your disposal. You want to make sure that you have something you can rely on time and time again. From the everyday time-sensitive tow to the heavy-duty recovery jobs, we provide you with the right tools to get the job done right. We are number one when it comes to towing for a reason.

Grade 70.....	5
Grade 80.....	14
Grade 100.....	16
Grade 120.....	20
Bulk Chain.....	21
Load Binders.....	22
Shackles.....	23
Coupling Links.....	24
D-Rings.....	25

G70 Chain with 15" J Hook;

Grab & Hammerhead T-J Combo Hooks on Other End

PART #	SIZE	LENGTH	WLL	UNIT
N711-6AH6	5/16"	6'	4,700 lb	PAIR
N711-6BH	5/16"	8'	4,700 lb	PAIR
N711-6H	5/16"	10'	4,700 lb	PAIR

PATENTED



G70 Chain with 15" J Hook;

Grab & Mini J Hooks on Other End

PART #	SIZE	LENGTH	WLL	UNIT
N711-6AJ6	5/16"	6'	4,700 lb	PAIR
N711-6BJ	5/16"	8'	4,700 lb	PAIR
N711-6J	5/16"	10'	4,700 lb	PAIR

PATENTED



G70 Chain

with 15" J Hook; Grab R, T & Mini J Hooks on Other End

PART #	SIZE	LENGTH	WLL	UNIT
N711-6LUG8	5/16"	8'	4,700 lb	PAIR
N711-6LUG10	5/16"	10'	4,700 lb	PAIR

PATENTED

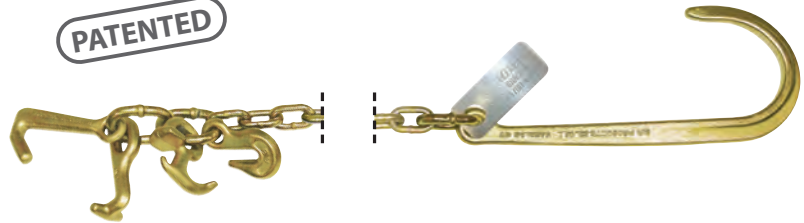

G70 Chain with 15" J Hook; Grab & T Hook on Other End

PART #	SIZE	LENGTH	WLL	UNIT
N711-6B	5/16"	8'	4,700 lb	PAIR
N711-6	5/16"	10'	4,700 lb	PAIR

PATENTED



G70 Chain with 15" J Hook; Grab Hook on Other End

PART #	SIZE	LENGTH	WLL	UNIT
N711-1	5/16"	8'	4,700 lb	PAIR

PATENTED



G70 Chain

with 15" J Hook; Grab & Compact J Hooks on Other End

PART #	SIZE	LENGTH	WLL	UNIT
N711-6M10	5/16"	10'	4,700 lb	PAIR

PATENTED



G70 Chain with 15" Classic Style J Hook;
Grab & Hammerhead T-J Combo Hooks on Other End

PART #	SIZE	LENGTH	WLL	UNIT
Z11-6H	5/16"	10'	4,700 lb	PAIR



G70 Chain
with 15" Classic Style J Hook; Grab & T Hooks on Other End

PART #	SIZE	LENGTH	WLL	UNIT
Z11-6	5/16"	10'	4,700 lb	PAIR



G70 Chain
with 15" Classic Style J Hook; Grab Hook on Other End

PART #	SIZE	LENGTH	WLL	UNIT
Z11-1	5/16"	8'	4,700 lb	PAIR



G70 Ultimate Axle Chain
with 8" J Hook; Grab & Slip Hooks on Other End

PART #	SIZE	LENGTH	WLL
N711-AC3S	5/16"	3'	4,700 lb

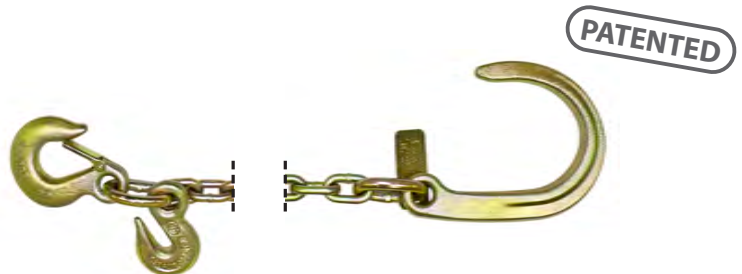

G70 Ultimate Axle Chain
with 8" J Hook; Grab Hooks on Other End

PART #	SIZE	LENGTH	WLL
N711-AC3	5/16"	3'	4,700 lb



G70 Chain with 8" J Hook;
Grab & Hammerhead T-J Combo Hooks on Other End

PART #	SIZE	LENGTH	WLL	UNIT
N711-6CH	5/16"	10'	4,700 lb	PAIR



CHAIN

Grade 70 J-Hooks & V-Chain

NEW PRODUCT DESIGN

G70 Chain with 15" J Hooks; T Hook, Mini J Hook & Grab Hook

PART #	SIZE	LENGTH	WLL	UNIT
N711-6BGJT	5/16"	8'	4,700 lb	PAIR

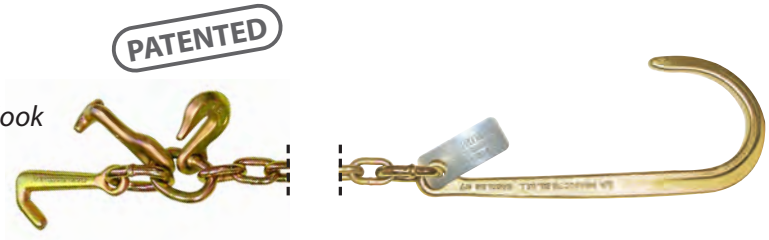

G70 Chain with 15" J Hook; T, Grab & Mini J Hooks on Other End

PART #	SIZE	LENGTH	WLL
N711-610C	5/16"	10'	4,700 lb

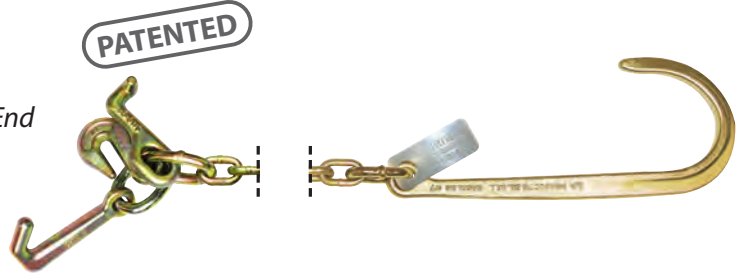

THE LOW PROFILE ADVANTAGE

Reduce damage to the under carriage of vehicles with the patented Low Profile V-Bridles.

The hook of the winch line is now in a horizontal plane, with the tip of the hook pointed away from components that could damage new vehicle designs. This reduces the risk of puncturing the vehicle's oil pan, transmission, valance, bumper, radiator, etc. V-Bridles work best with Swivel Hook style rope assemblies.

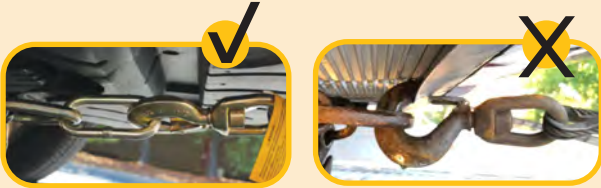

PATENTED

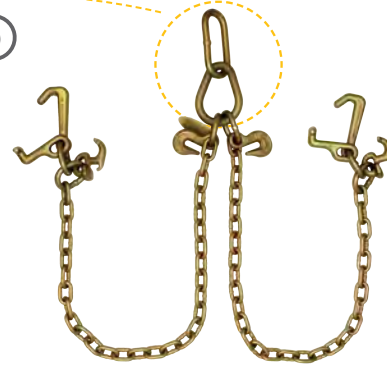

Low Profile G70 V-Chain with R, T & Mini J Hooks

PART #	SIZE	LEGS	WLL @ 60°
LP11-8LU2	5/16"	2'	5,400 lb
LP11-8LU	5/16"	3'	5,400 lb
LP11-8LU6	5/16"	6'	5,400 lb

PATENTED



Low Profile G70 V-Chain

with 8" J Hooks & Hammerhead T-J Combo Hooks

PART #	SIZE	LEGS	WLL @ 60°
LP11-8DH	5/16"	2'	5,400 lb
LP11-8DH3	5/16"	3'	5,400 lb

PATENTED



Low Profile G70 V-Chain with 15" J Hooks & T Hooks

PART #	SIZE	LEGS	WLL @ 60°
LP11-8T	5/16"	2'	5,400 lb
LP11-8T3	5/16"	3'	5,400 lb



Low Profile G70 V-Chain with 8" J Hooks & Mini J Hooks

PART #	SIZE	LEGS	WLL @ 60°
LP11-8DJ	5/16"	2'	5,400 lb
LP11-8DJ3	5/16"	3'	5,400 lb



Low Profile G70 V-Chain with 8" J Hooks & T Hooks

PART #	SIZE	LEGS	WLL @ 60°
LP11-8DT	5/16"	2'	5,400 lb
LP11-8DT3	5/16"	3'	5,400 lb



Low Profile G70 V-Chain with 15" J Hooks & Hammerhead T-J Combo Hooks

PART #	SIZE	LEGS	WLL @ 60°
LP11-8H	5/16"	2'	5,400 lb
LP11-8H3	5/16"	3'	5,400 lb



Low Profile G70 V-Chain with 15" J Hooks & Mini J Hooks

PART #	SIZE	LEGS	WLL @ 60°
LP11-8J	5/16"	2'	5,400 lb
LP11-8J3	5/16"	3'	5,400 lb



Low Profile G70 V-Chain with 15" J Hooks

PART #	SIZE	LEGS	WLL @ 60°
LP11-8	5/16"	2'	5,400 lb
LP11-8-3	5/16"	3'	5,400 lb



Low Profile G70 V-Chain with 15" J Hooks & Compact J Hooks

PART #	SIZE	LEGS	WLL @ 60°
LP11-8M2	5/16"	2'	5,400 lb

CHAIN

Grade 70 V-Chain

PATENTED



Low Profile G70 V-Chain with 8" J Hooks

PART #	SIZE	LEGS	WLL @ 60°
LP11-8D	5/16"	2'	5,400 lb

PATENTED



Low Profile G70 V-Chain with Mini J Hooks

PART #	SIZE	LEGS	WLL @ 60°
LP11-8MJ	5/16"	2'	5,400 lb

PATENTED



Low Profile G70 V-Chain with R Hooks & Hammerhead T-J Combo Hooks

PART #	SIZE	LEGS	WLL @ 60°
LP11-8RH	5/16"	3'	5,400 lb



G70 V-Chain with 8" Classic Style J Hooks & Hammerhead T-J Combo Hooks

PART #	SIZE	LEGS	WLL @ 60°
Z11-8DH	5/16"	2'	5,400 lb



G70 V-Chain with 15" Classic Style J Hooks & Hammerhead T-J Combo Hooks

PART #	SIZE	LEGS	WLL @ 60°
Z11-8H	5/16"	2'	5,400 lb



G70 V-Chain with 15" Classic Style J Hooks

PART #	SIZE	LEGS	WLL @ 60°
Z11-8	5/16"	2'	5,400 lb

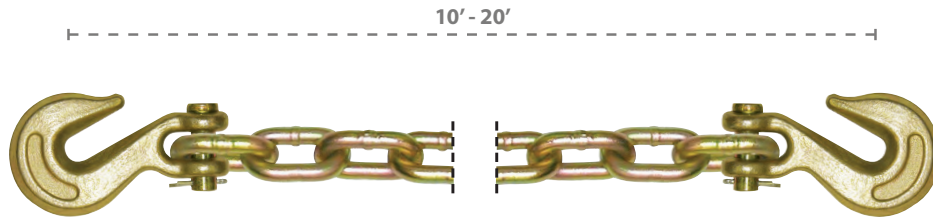

G70 Binder Safety Chain with Clevis Grab Hook on Both Ends

PART #	SIZE	LENGTH	PART #	SIZE	LENGTH	PART #	SIZE	LENGTH
11A-516G710	5/16"	10'	11A-38G710	3/8"	10'	11A-12G710	1/2"	10'
11A-516G715	5/16"	15'	11A-38G715	3/8"	15'	11A-12G715	1/2"	15'
11A-516G720	5/16"	20'	11A-38G720	3/8"	20'	11A-12G720	1/2"	20'
WLL 4,700 lb			WLL 6,600 lb			WLL 11,300 lb		

G70 Safety Chain with Twist Lock™ Grab Hook on One End

PART #	SIZE	LENGTH	WLL
G7-51610ST	5/16"	10'	4,700 lb
G7-3810ST	3/8"	10'	6,600 lb



G70 Safety Chain with Heavy Duty Sling Hook on One End

PART #	SIZE	LENGTH	WLL	UNIT
N711-11ALH	5/16"	10'	4,700 lb	PAIR
N711-3212	5/16"	12'	4,700 lb	EA



G70 Safety Chain with Eye Slip Hook on One End

PART #	SIZE	LENGTH	WLL
N711-3210	5/16"	10'	4,700 lb



G70 Safety Chain with Clevis Grab Hook on One End

PART #	SIZE	LENGTH	WLL	UNIT
N711-11D	5/16"	10'	4,700 lb	PAIR



CARRIER SAFETY CHAINS can be used as primary or secondary securement chains on all types of carriers. Open end chains are used to permanently mount to carrier decks or in chain pockets.

G70 Chain with Twist Lock™ Grab Hook on Each End

PART #	SIZE	LENGTH	WLL
G7-3820TL	3/8"	20'	6,600 lb



- TWIST LOCK™ DESIGN BENEFITS:**
- Strong, secure latch
 - Easy to install, easy to use
 - Reduces risk of accidental release of chain
 - Reduces risk of inadvertent re-hooking

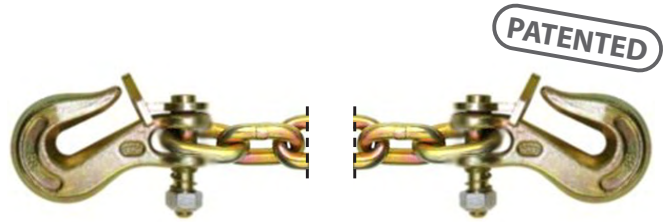

PATENTED

G70 Chain with Grab & Hammerhead T-J Combo Hooks on One End

PART #	SIZE	LENGTH	WLL
N711-HG8	5/16"	8'	4,700 lb

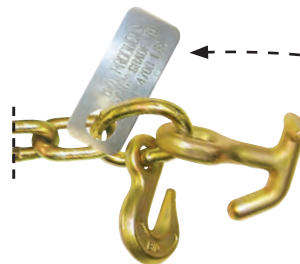

RATED PRODUCTS ARE WELDED, TESTED & TAGGED!



WELDED, TESTED & TAGGED B/A takes pride in controlling the weld process in our Columbia, MD facility, batch testing, and tagging rated products. Products come tagged with a rated working load limit where applicable.

G70 Chain with Grab Hook; R, T & Mini J Hooks on Other End

PART #	SIZE	LENGTH	WLL	UNIT
N711-GCL8	5/16"	8'	4,700 lb	PAIR
N711-GCL10	5/16"	10'	4,700 lb	PAIR



G70 Mini Datsun Grab Hook Combo

PART #	WLL
11-7MDG	3,150 lb



G70 (2) Grab Hooks on Pear Link

PART #	SIZE	WLL
N711-8E	5/16"	Straight 4,700 lb @ 60° 5,400 lb



G70 Weldable Grab Hook

PART #	SIZE	WLL
11-516WGH	5/16"	4,700 lb
11-38WGH	3/8"	6,600 lb
11-12WGH	1/2"	11,300 lb
11-58WGH	5/8"	15,800 lb



G70 Eye Grab Hook

PART #	SIZE	WLL
11-38G7EGH	3/8"	11,300 lb



G70 Clevis Grab Hook

PART #	SIZE	WLL
11-516G7H	5/16"	4,700 lb
11-38G7H	3/8"	6,600 lb



G70 R, T & Mini J Hook Cluster on Oblong Link

PART #	WLL
11-7CL	4,700 lb



G70 Grab, R, T & Mini J Hook Cluster

PART #	WLL
11-7CL-G	4,700 lb



G70 T & Grab Hook Combo

PART #	WLL
11-7D	4,700 lb



G70 Grab, T & Mini J Hook Cluster on Oblong Link

PART #	WLL
11-7GMT	4,700 lb



G70 2 Grab Hooks on Link

PART #	WLL
BAP-GG	4,700 lb



G70 Grab & Mini J Hooks on Oblong Link

PART #	WLL
BAP-GJ	4,700 lb



G70 T & Mini J Hooks on Oblong Link

PART #	WLL
11-7JTO	4,700 lb



G70 Clevis Slip Hook with Latch

PART #	SIZE	WLL
11-516G7SHL	5/16"	4,700 lb
11-38G7SHL	3/8"	6,600 lb
11-12G7SHL	1/2"	11,300 lb



B/A EXCLUSIVE

G70 Twist Lock™ Slip Hook

Constructed of heavy gauge steel, swivels 360° & helps prevent accidental hooking or catching onto other objects.

PART #	SIZE	WLL
G7-205-516	5/16"	4,700 lb
G7-205-38	3/8"	6,600 lb
G7-205-12	1/2"	11,300 lb



PATENTED



G70 Classic Style J Hook

PART #	DESCRIPTION	SIZE	WLL
Z11-10	Hook Only	8"	5,400 lb
Z11-10-L	On Link	8"	5,400 lb



G70 Classic Style J Hook

PART #	SIZE	WLL
Z11-2	15"	5,400 lb

PATENTED



G70 FORGED J Hook

PART #	SIZE	WLL
N711-10	8"	5,400 lb
N711-2	15"	5,400 lb

PATENTED



G70 FORGED J Hook on Link

PART #	SIZE	WLL
N711-10-L	8"	5,400 lb
N711-2-L	15"	5,400 lb



G70 FORGED Clevis J Hook

PART #	SIZE	WLL
N711-10CL	8"	5,400 lb
N711-2CL	15"	5,400 lb

Colors May Vary | Colors Do Not Correspond To Grade | Always Check Tag, Hook, & Chain Stamp To Confirm Grade

G80 Chain Kit

Kit includes (4) Chains:

(2) 10' Chain; Cradle Grab Hooks

(2) 20' Chain; Cradle Grab Hooks

PART #	SIZE	WLL
G8-SGG516	5/16"	5,350 lb
G8-SGG38	3/8"	7,100 lb

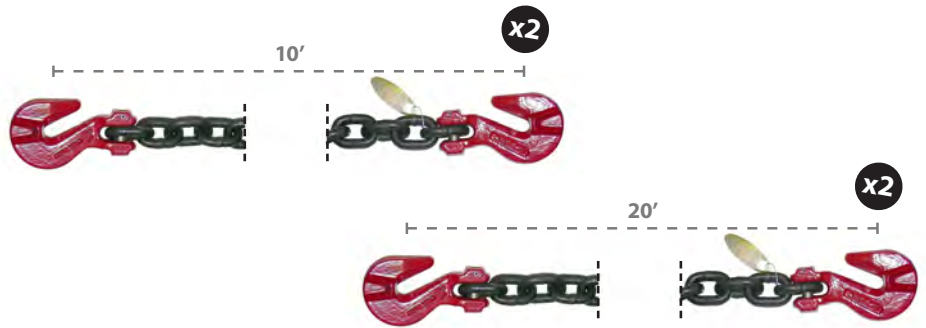

G80 Chain with 15" J Hook & Cradle Grab Hook

PART #	SIZE	LENGTH	WLL
G8-3810GJ	3/8"	10'	7,100 lb



G80 Chain with 15" J Hook, Grab Hook & Master Link

PART #	SIZE	LENGTH	WLL
G8-3810JOG	3/8"	10'	7,100 lb



WRECKMASTER

G80 Front Axle Tie Down Kit

(2) Chains with Container Link & Omega Link

(1) Binder (1) Application Guide Book

PART #	SIZE	WLL
WM-701022	3/8"	7,100 lb



ACTUAL COLORS MAY VARY

B/A EXCLUSIVE

G80 Twist Lock™ Clevis Grab Hook

PART #	SIZE	WLL
8-200-14	1/4"	3,500 lb
8-200-516	5/16"	4,500 lb
8-200-38	3/8"	7,100 lb
8-200-12	1/2"	12,000 lb
8-200-58	5/8"	18,100 lb



G80 3/8" V-Chain with 15" J Hook

PART #	LENGTH
G8-118-3	3'
G8-118-6	6'
G8-118-10	10'

WLL
Straight Pull 7,100 lb
@ 60° 12,000 lb





B/A partners with organizations that align with our mission of keeping you safe. Yoke's motto is, 'pursue quality perfection, constant innovation, and safety,' and has demonstrated their commitment to safety through their delivery of tried and true quality products used in the industry for many years now. Yoke's Grade 80 products are proof tested to twice their working load limit, and Grade 100 products are proof tested to 2.5 times their working load limits. These products are also thoroughly evaluated through the magnaflux quality control process before they go anywhere.



G80 Container Hook

Use what the pros use to lift sea containers. These hooks were developed to be used on the corner eyes of a sea container during a direct lift. They are available in left and right versions for using as a sling or a 90 degree version for direct lifting. These are designed for lifting purposes only.

PART #	SIZE	WLL
8-067-45LT	Left 45°	28,000 lb
8-067-45RH	Right 45°	28,000 lb
8-067-STR	Straight	28,000 lb



Left 45°



Right 45°



Straight

ACTUAL COLORS MAY VARY



G80 Excavator Weld-On Hook

The weld on anchor hooks are designed for weldable attachment to equipment to provide a lifting/ pulling point for easy attachment of chain, wire rope, or web slings.

PART #	SIZE	WLL	PART #	SIZE	WLL
8-081-01	1 T	2,200 lb	8-081-05	5 T	11,000 lb
8-081-02	2 T	4,400 lb	8-081-08	8 T	17,600 lb
8-081-03	3 T	6,600 lb	8-081-10	10 T	22,000 lb
8-081-04	4 T	8,800 lb	8-081-15	15 T	33,000 lb



G80 Latch Kit Replacement Kit for Yoke Sling Hook

PART #	SIZE	TO FIT
8-P044-07	1/4" - 5/16"	3 Ton Alloy/ 2T Carbon
8-P044-10	3/8"	4.5 Tons Alloy/ 3T Carbon
8-P044-13	1/2"	7 Tons Alloy/ 5T Carbon
8-P044-16	5/8"	11 Tons Alloy/ 7T Carbon





G100 Chain with Frame Hook & Coupling Link on One End; Twist Lock™ Grab Hook on Other End

PART #	SIZE	LENGTH	WLL
11-0622700	1/2"	5'	15,000 lb



G100 Chain with Non-Cradle Grab Hooks

PART #	SIZE	LENGTH	WLL
G10-3810NCG	3/8"	10'	8,800 lb
G10-1210NCG	1/2"	10'	15,000 lb
G10-1220NCG	1/2"	20'	15,000 lb



ACTUAL COLORS MAY VARY

G100 Chain with Cradle Grab Hooks

PART #	SIZE	LENGTH	PART #	SIZE	LENGTH
G10-51610SGG	5/16"	10'	G10-1210SGG	1/2"	10'
G10-51620SGG	5/16"	20'	G10-1220SGG	1/2"	20'
G10-3810SGG	3/8"	10'	G10-5810SGG	5/8"	10'
G10-3820SGG	3/8"	20'	G10-5810SGG	5/8"	20'

WLL 5/16" 5,700 lb | 3/8" 8,800 lb | 1/2" 15,000 lb | 5/8" 22,600 lb



G100 Chain

with Oblong Link on One End; Foundry Hook on Other End

PART #	SIZE	LENGTH	WLL
G10-12FH1	1/2"	2'	15,000 lb
G10-58FH1	5/8"	2'	22,600 lb

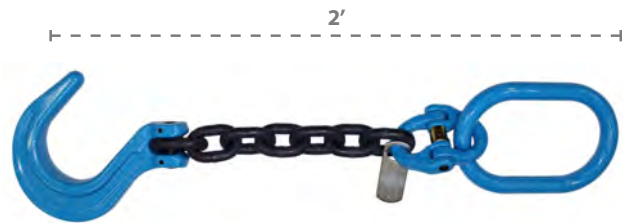

ACTUAL COLORS MAY VARY

G100 Chain Kit

Kit includes (4) Chains:

- (2) 10' Chain; Non-Cradle Grab Hooks
- (2) 20' Chain; Non-Cradle Grab Hooks

PART #	SIZE	WLL
G10-NCG12	1/2"	15,000 lb

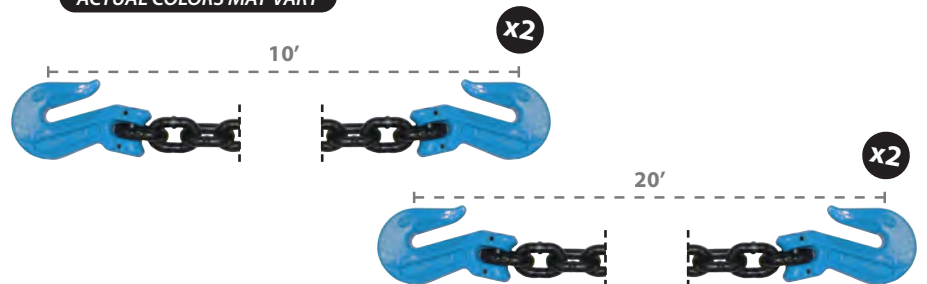

G100 Chain with Twist-Lock Cradle Grab Hooks

PART #	SIZE	LENGTH	PART #	SIZE	LENGTH
G10-51610TL	5/16"	10'	G10-1210TL	1/2"	10'
G10-51620TL	5/16"	20'	G10-1220TL	1/2"	20'
G10-3810TL	3/8"	10'	G10-5810TL	5/8"	10'
G10-3820TL	3/8"	20'	G10-5820TL	5/8"	20'

WLL 5/16" 5,700 lb | 3/8" 8,800 lb | 1/2" 15,000 lb | 5/8" 22,600 lb



CHAIN

Grade 100 Chain Assemblies

ACTUAL COLORS MAY VARY



G100 Axle Chain Kit

(2) 6' G100 3/8" Chains with Container Link & Omega Link
(1) Quikbinder Plus Ratchet Load Binder

PART #	SIZE	LENGTH	WLL
G10-FA386KIT	3/8"	6'	8,800 lb
G10-FA126KIT	1/2"	6'	15,000 lb



G100 Sea Container Loading Bridle

PART #	SIZE	LENGTH	WLL @ 30°
G10-38DC	3/8"	5'	8,800 lb
G10-12DC	1/2"	5'	15,000 lb

B/A EXCLUSIVE

G100 Hi-Viz Chain with Twist Lock Cradle Grab Hooks

PART #	SIZE	LENGTH	WLL
H10-3810TL	3/8"	10'	8,800 lb
H10-3820TL	3/8"	20'	8,800 lb
H10-1210TL	1/2"	10'	15,000 lb
H10-1220TL	1/2"	20'	15,000 lb



PATENTED

B/A EXCLUSIVE

G100 Hi-Viz Chain with Twist Lock Non-Cradle Grab Hooks

PART #	SIZE	LENGTH	WLL
H10-3820NTL	3/8"	20'	8,800 lb
H10-1210NTL	1/2"	10'	15,000 lb
H10-1220NTL	1/2"	20'	15,000 lb



PATENTED

G100 Hi-Viz Chain with Cradle Grab Hooks

PART #	SIZE	LENGTH	WLL
H10-3810SGG	3/8"	10'	8,800 lb
H10-3820SGG	3/8"	20'	8,800 lb
H10-1220SGG	1/2"	20'	15,000 lb

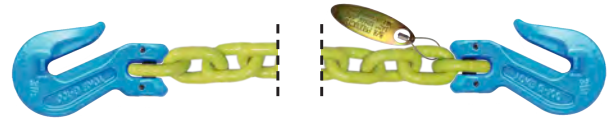

G100 Hi-Viz Chain with Non-Cradle Grab Hooks

PART #	SIZE	LENGTH	WLL
H10-3810NCG	3/8"	10'	8,800 lb
H10-3820NCG	3/8"	20'	8,800 lb
H10-1210NCG	1/2"	10'	15,000 lb
H10-1220NCG	1/2"	20'	15,000 lb

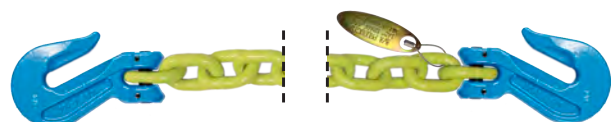

5/16" G80 Chain; Cradle Grab Hooks

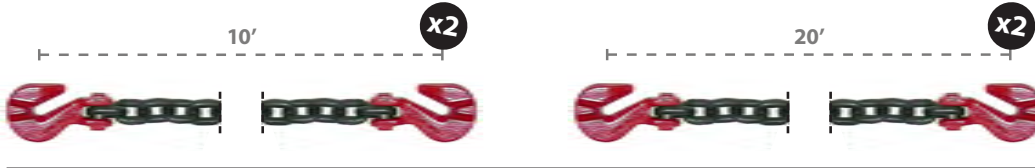

3/8" G80 Chain; Cradle Grab Hooks

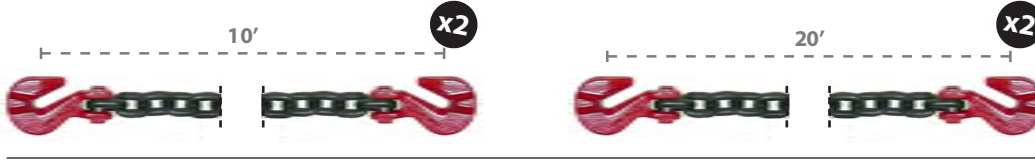

1/2" G100 Chain; Non-Cradle Grab Hooks

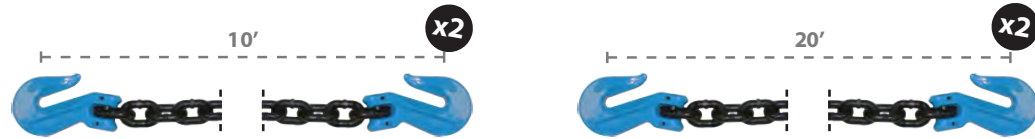

Heavy Duty Chain Kit

Includes (12) Pieces:

Chain lengths consist of (6) 10' & (6) 20'

Other kit options available on baprod.com.

PART #	WT
11-HDCK	362 lb

Includes:

(4) 5/16" G80 Chain; Cradle Grab Hooks

(4) 3/8" G80 Chain; Cradle Grab Hooks

(4) 1/2" G100 Chain; Non-Cradle Grab Hooks

(2) 5/16" - 3/8" Ratchet Load Binder

WLL

5,350 lb

7,100 lb

15,000 lb

8,800 lb



G100 Shortening Clutch

PART #	SIZE	WLL
X-078-10	3/8"	8,800 lb
X-078-13	1/2"	15,000 lb



G100 Master Link with Two Shortening Hooks

PART #	CHAIN SIZE	WLL @ 60°
G10-137-38	3/8"	15,200 lb
G10-137-12	1/2"	26,000 lb
G10-137-58	5/8"	39,100 lb



G100 Twist Lock™ Cradle Grab Hook

PART #	SIZE	WLL
G10-206-516	5/16"	5,700 lb
G10-206-38	3/8"	8,800 lb
G10-206-12	1/2"	15,000 lb
G10-206-58	5/8"	22,600 lb



G100 Twist Lock™ Non-Cradle Grab Hook

PART #	SIZE	WLL
G10-208-516	5/16"	5,700 lb
G10-208-38	3/8"	8,800 lb
G10-208-12	1/2"	15,000 lb
G10-208-58	5/8"	22,600 lb



G100 Coupling Link with Frame Hook

PART #	WLL
11-MFHK	15,000 lb



Designed to provide an improved connection point to truck and trailer frames without tip loading the hook for an even distribution of weight.



G100 Clevis Self-Locking Hook

PART #	SIZE	WLL
X-026-07	5/16"	5,700 lb
X-026-10	3/8"	8,800 lb
X-026-13	1/2"	15,000 lb
X-026-16	5/8"	22,600 lb
X-026-20	3/4"	35,300 lb



G100 Clevis Sling Hook with Latch

PART #	SIZE	WLL
X-043/S-07	5/16"	5,700 lb
X-043/S-10	3/8"	8,800 lb
X-043/S-13	1/2"	15,000 lb
X-043/S-16	5/8"	22,600 lb
X-043/S-20	3/4"	35,300 lb



ACTUAL COLORS MAY VARY

G100 Clevis Grab Hook

PART #	SIZE	WLL
X-0421-07	5/16"	5,700 lb
X-0421-10	3/8"	8,800 lb
X-0421-13	1/2"	15,000 lb



G100 Clevis Cradle Grab Hook

PART #	SIZE	WLL
X-042-07	5/16"	5,700 lb
X-042-10	3/8"	8,800 lb
X-042-13	1/2"	15,000 lb



G100 Foundry Hook

PART #	SIZE	WLL
X-046-07	5/16"	5,700 lb
X-046-10	3/8"	8,800 lb
X-046-13	1/2"	15,000 lb
X-046-16	5/8"	22,600 lb



G100 Clutch Sling Hook with Latch

PART #	SIZE	WLL
X-077-10	3/8"	8,800 lb
X-077-13	1/2"	15,000 lb
X-077-16	5/8"	22,600 lb



G120 Chain with Cradle Grab Hooks

PART #	SIZE	LENGTH	WLL
G12-3810SGG	3/8"	10'	10,600 lb
G12-3820SGG	3/8"	20'	10,600 lb
G12-1210SGG	1/2"	10'	17,900 lb
G12-1220SGG	1/2"	20'	17,900 lb

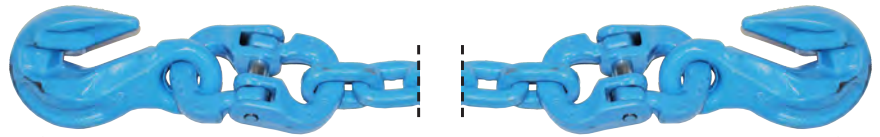

G120 Hi-Viz Chain with Cradle Grab Hooks

PART #	SIZE	LENGTH	WLL
H12-3810SGG	3/8"	10'	10,600 lb
H12-3820SGG	3/8"	20'	10,600 lb
H12-1210SGG	1/2"	10'	17,900 lb
H12-1220SGG	1/2"	20'	17,900 lb

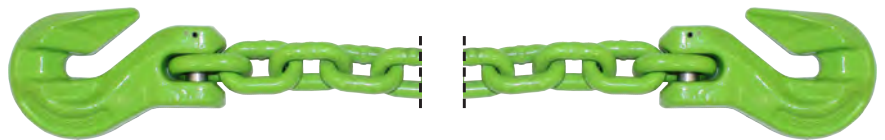

G120 Hi-Viz Clevis Grab Hook

PART #	SIZE	WLL
H12-107-932	9/32"	5,200 lb
H12-107-516	5/16"	6,600 lb
H12-107-38	3/8"	10,600 lb
H12-107-12	1/2"	17,900 lb



G120 Hi-Viz Clevis Sling Hook

PART #	SIZE	WLL
H12-111-932	9/32"	5,200 lb
H12-111-516	5/16"	6,600 lb
H12-111-38	3/8"	10,600 lb
H12-111-12	1/2"	17,900 lb



HI-VIZ G120 CHAIN



Weather Resistant



High Visibility
For Safety



High Quality
G120 Chain



CHAIN

Bulk Chain

G70 Yellow Zinc Plated Chain

Produced from heat treated carbon steel. The standard for towing, logging and tie-down applications. Yellow Zinc Plated for easy identification.

PART #	SIZE	WLL
11-516G7	5/16"	4,700 lb
11-38G7	3/8"	6,600 lb
11-12G7	1/2"	11,300 lb



! NOT Approved for Overhead Lifting!

G80 Alloy Chain

Chain is made from alloy steel. Meets or exceeds NACM, ASTM AND OSHA specifications. Black protective coating.

PART #	SIZE	WLL
G8-516	5/16"	4,500 lb
G8-38	3/8"	7,100 lb
G8-12	1/2"	12,000 lb
G8-58	5/8"	18,100 lb



G100 Chain

Special alloy steel. Meets or exceeds NACM, ASTM and OSHA specs. Gray protective coating.

PART #	SIZE	WLL
G10-101-516	5/16"	5,700 lb
G10-101-38	3/8"	8,800 lb
G10-101-12	1/2"	15,000 lb
G10-101-58	5/8"	22,600 lb
G10-101-34	3/4"	35,300 lb



G120 Chain

Grade 120 chain has 50% higher work load limit compared to Grade 80 and 20% higher work load limit compared to Grade 100. Blue coat finish.

PART #	SIZE	WLL
G12-38	3/8"	10,600 lb
G12-12	1/2"	17,900 lb



G100 Hi-Viz Chain

High visibility yellow for safer work. Weather resistant.

PART #	SIZE	WLL
H10-101-38	3/8"	8,800 lb
H10-101-12	1/2"	15,000 lb



G120 Hi-Viz Chain

High visibility green for safer work. Weather resistant.

PART #	SIZE	WLL
H12-101-38	3/8"	10,600 lb
H12-101-12	1/2"	17,900 lb



PATENTED



Upper Hand Ratchet Binder

PART #	CHAIN SIZE	WLL
11-UHRB-1	5/16" - 3/8"	6,600 lb



Ratchet Load Binder

PART #	CHAIN SIZE	WLL
11-RTL-3	5/16" - 3/8"	6,600 lb
11-RTL-4	5/16" - 3/8"	8,800 lb
11-RTL-1	3/8" - 1/2"	9,200 lb
11-RTL-12	3/8" - 1/2"	12,000 lb
11-RTL-2	1/2" - 5/8"	13,000 lb
11-RTL-8	1/2" - 5/8"	16,000 lb



Lever Load Binder

PART #	CHAIN SIZE	WLL
11-LLB-3	5/16" - 3/8"	6,600 lb
11-LLB-1	3/8" - 1/2"	9,200 lb



Binders designed for load securement are not approved for overhead lifting applications. Products for lifting require certification. For more information please visit: wstda.com or read WSTDA T6, section 4.3.7



QuikBinder Plus

PART #	CHAIN SIZE	WLL
11-QBDR100	5/16" - 3/8"	7,100 lb
11-QBDR12	3/8" - 1/2"	12,000 lb
11-QBDR18	1/2" - 5/8"	18,100 lb



Ratchet Load Binder with T Handle

PART #	CHAIN SIZE	WLL
11-RTL-38T	5/16" - 3/8"	7,100 lb



Under Reach Load Binder with Chain & Grab Hook

PART #	CHAIN SIZE	WLL
11-URLB	5/16" - 3/8"	6,600 lb



Carbon Screw Pin Anchor Shackles

PART #	SIZE	WLL	PART #	SIZE	WLL
11-38SPAS	3/8"	1T	11-1SPAS	1"	8.5T
11-12SPAS	1/2"	2T	11-118SPAS	1 1/8"	9.5T
11-58SPAS	5/8"	3.25T	11-125SPAS	1 1/4"	12T
11-34SPAS	3/4"	4.75T	11-150SPAS	1 1/2"	17T
11-78SPAS	7/8"	6.5T			



Alloy Screw Pin Anchor Shackles

PART #	SIZE	WLL	PART #	SIZE	WLL
11-AS12	1/2"	3.3T	11-AS1	1"	12.5T
11-AS58	5/8"	5T	11-AS125	1 1/4"	18T
11-AS34	3/4"	7T	11-AS150	1 1/2"	30T
11-AS78	7/8"	9.5T			



Alloy Anchor Shackle

PART #	SIZE	WLL
8-838-11	7/16"	1.5T
8-838-13	1/2"	2T
8-808-19	3/4"	7T



B/A EXCLUSIVE Twist Lock™ Shackle

PART #	SIZE	WLL
11-TLS34	3/4"	7T
11-TLS1	1"	12.5T
11-TLS125	1 1/4"	18T



PATENTED

TWIST LOCK™ BENEFITS

- Forged Alloy Steel with Alloy Pin
- Open Cross Pin becomes Stable Handle
- Size & WLL Stamped into Shackle
- 100% Magnaflux Tested
- No Tools Required to Operate



**Quickly Lock
& Unlock**



**Pin Retracts without
Becoming Loose**



**Pin Permanently
Attached to Shackle**



G70 Double Clevis

PART #	SIZE	WLL
11-DC516	5/16"	4,700 lb
11-DC38	3/8"	6,600 lb
11-DC4	5/16" - 3/8"	6,600 lb
11-DC12	1/2"	11,300 lb



G80 Coupling Link

PART #	SIZE	WLL
8-015-13	1/2"	5.3 T
8-015-16	5/8"	8 T
8-015-20	3/4"	12.5 T



G80 Omega Link

PART #	SIZE	WLL
8-018-10	3/8"	3.15 T
8-018-13	1/2"	5.3 T



G100 Coupling Link

PART #	SIZE	WLL
X-015-07	1/4" - 5/16"	5,700 lb
X-015-10	3/8"	8,800 lb
X-015-13	1/2"	15,000 lb
X-015-16	5/8"	22,600 lb
X-015-20	3/4"	35,300 lb



G100 Container Eye Link

PART #	DESCRIPTION	SIZE	WLL
CL-1034	Standard	3/4"	35,300 lb
CL-7034	Web Sling	3/4"	35,300 lb



G100 Web Sling Connector

PART #	SIZE	WLL
X-016-07	1/4" - 5/16"	5,700 lb
X-016-10	3/8"	8,800 lb
X-016-13	1/2"	15,000 lb
X-016-16	5/8"	22,600 lb
X-016-20	3/4"	35,300 lb



G120 Hi-Viz Coupling Link

PART #	SIZE	WLL
H12-103-932	9/32"	5,200 lb
H12-103-516	5/16"	6,600 lb
H12-103-38	3/8"	10,600 lb
H12-103-12	1/2"	17,900 lb





Bolt-On D-Ring

PART #	DESCRIPTION	SIZE	WLL
38-DR1	Plated	1/2"	4,080 lb
38-DR1SC	Self Colored	1/2"	4,080 lb



Weld-On D-Ring

PART #	SIZE	WLL
38-DR58	5/8"	6,130 lb
38-DR34	3/4"	9,120 lb
38-DR2	1"	15,580 lb



G80 Weld-On Point

PART #	WLL
8-057-1T	1 T
8-057-3T	3 T
8-057-5T	5 T



1" Forged Curved Steel D-Ring

PART #	WLL
38-DR355	15,560 lb

B/A Products Co., as a manufacturer of chain assemblies, can only control the specifications of our chain products in accordance with industry and governmental standards. It would be impossible for any warning to contain all of the possible misapplications associated with the use of our products. Our warnings are intended to identify only those risks which are most common. The responsibility and understanding of the proper safe use and application of the products in our catalog, ultimately rest with the end user. Failure of the product can occur due to misapplication, abuse, intentional alteration or improper maintenance. Product failure can result in property damage, personal injury or death.

Working Load Limit (WLL): The maximum load that shall be applied in direct tension to an undamaged straight length of chain, webbing, rope or fittings.

Chain Doesn't "Just Break"



Once welded, the chain is proof-tested to the industry standard. Proof testing is the procedure whereby each link is tested to twice its Working Load Limit (WLL). By definition, the WLL is the maximum load the chain is warranted to handle.

- All Working Load Limits (WLL) shown in this catalog apply only to new or "in as new" condition products.

- USE ONLY GRADE 80, 100 or 120 Chain and Attachments for overhead lifting.

- B/A Products Co. chain products are intended to be used at or below the Working Load Limits (WLL) specified in constantly increasing force applications under direct tension or in a straight line pull.

- Shock loading is prohibited and side loading must be avoided as it exerts additional dynamic forces or loading which the product is not designed to accommodate.

- The conditions involving use in certain environmental situations such as unusual (high or low) temperature, chemicals, etc., can cause changes in chain performance.

- Consult B/A Products for additional information or questions regarding the use and application of the products covered in this catalog.

PROOF TESTING

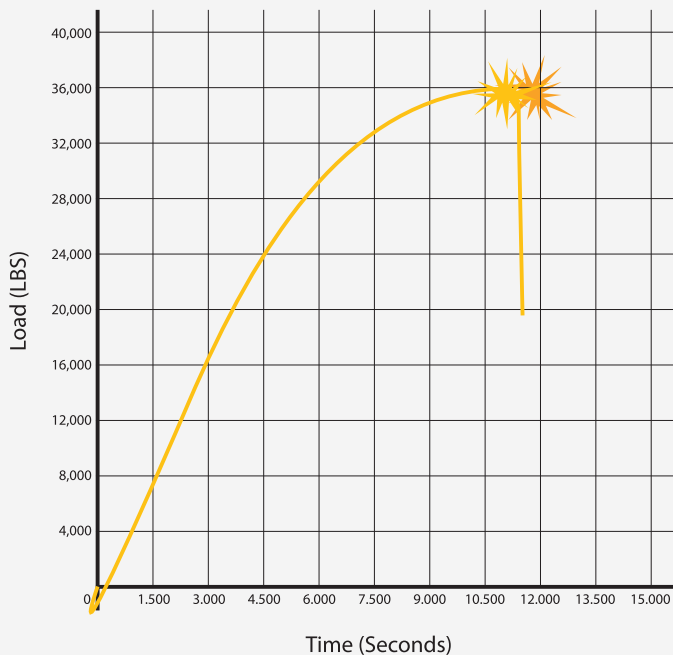

The Working Load Limits and the associated safety factor of our products may be affected by wear, misuse, overloading, corrosion, deformation, intentional alteration and other use conditions. Regular inspection must be conducted to determine whether use can be continued at the assigned Working Load Limit, a reduced Working Load Limit or whether the product must be withdrawn from service. The term "Working Load Limit" contains no implication of what load the product will withstand if the product is abused and/ or misused. B/A Products Co. accepts no liability for such abuse or misuse.

THE USE OF CHAIN IS SUBJECT TO CERTAIN HAZARDS THAT CANNOT BE MET BY MECHANICAL MEANS, BUT ONLY BY THE EXERCISE OF INTELLIGENCE, CARE AND COMMON SENSE.

Please visit www.nacm.info for added specifications & warnings.



CLASSIC

Flexibility	■ ■ ■ ■ ■
Abrasion Resistance	■ ■ ■ ■ ■ ■ ■ ■ ■ ■
Weather Resistance	■ ■ ■ ■ ■ ■ ■ ■ ■ ■
Overall Strength	■ ■ ■ ■ ■ ■ ■ ■ ■ ■
Visibility	■ ■ ■ ■ ■



HI-VIZ

Flexibility	■ ■ ■ ■ ■
Abrasion Resistance	■ ■ ■ ■ ■ ■ ■ ■ ■ ■
Weather Resistance	■ ■ ■ ■ ■ ■ ■ ■ ■ ■
Overall Strength	■ ■ ■ ■ ■ ■ ■ ■ ■ ■
Visibility	■ ■ ■ ■ ■ ■ ■ ■ ■ ■



TOWERS EDGE

Flexibility	■ ■ ■ ■ ■
Abrasion Resistance	■ ■ ■ ■ ■ ■ ■ ■ ■ ■
Weather Resistance	■ ■ ■ ■ ■ ■ ■ ■ ■ ■
Overall Strength	■ ■ ■ ■ ■ ■ ■ ■ ■ ■
Visibility	■ ■ ■ ■ ■



HEAVY DUTY (B.A.H.D)

Flexibility	■ ■ ■ ■ ■
Abrasion Resistance	■ ■ ■ ■ ■ ■ ■ ■ ■ ■
Weather Resistance	■ ■ ■ ■ ■ ■ ■ ■ ■ ■
Overall Strength	■ ■ ■ ■ ■ ■ ■ ■ ■ ■
Visibility	■ ■ ■ ■ ■



Towing for a Cure

Flexibility	■ ■ ■ ■ ■
Abrasion Resistance	■ ■ ■ ■ ■ ■ ■ ■ ■ ■
Weather Resistance	■ ■ ■ ■ ■ ■ ■ ■ ■ ■
Overall Strength	■ ■ ■ ■ ■ ■ ■ ■ ■ ■
Visibility	■ ■ ■ ■ ■

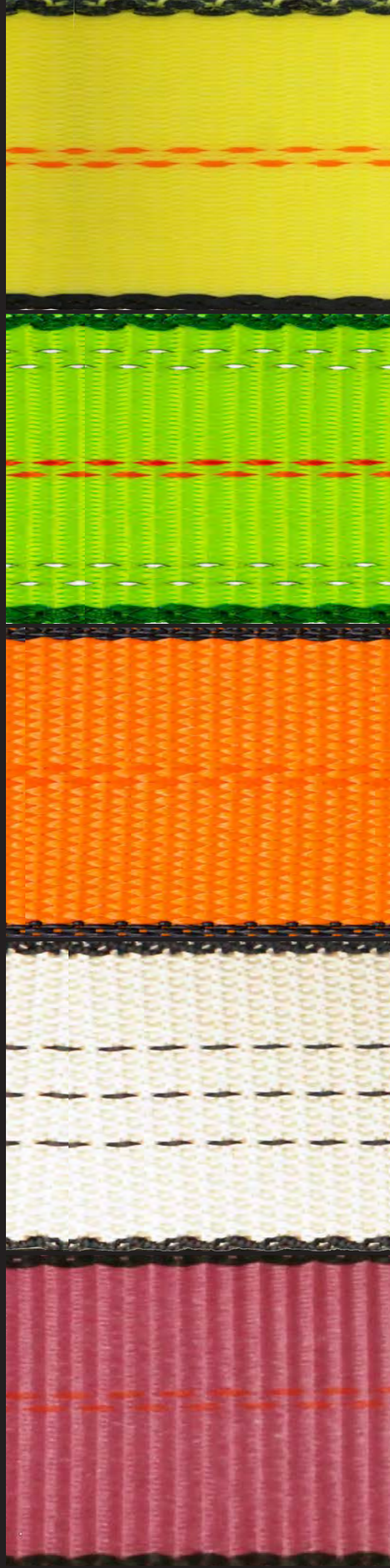

B/A's quality Classic polyester webbing has been chosen as the Tower's workhorse strap for decades and has become the standard for everyday use in the towing industry.

B/A's Hi-Viz webbing is hard to miss. Building on B/A's Classic web construction, this Hi-Viz Reflective Web takes roadside safety a step further. Between the reflective threads, and bright green color, this web promotes visibility on the roadside.

Towers Edge webbing is PVB impregnated to give maximum protection against the elements, resisting water and other fluids up to 50% more than standard web. The enhanced acrylic web coating and black thermoplastic coated edges provides a more durable finish.

Feel the difference with this Heavy Duty webbing with over 50% more Fibers than our classic webbing! The added benefits for this thicker, heavier design is longevity, durability and superior abrasion resistance. Natural color resists fading.

B/A began the Towing for a Cure initiative in 2014 to support finding a cure for Breast Cancer. Using the same classic webbing dyed a bright pink and stenciled Towing for a Cure, our industry is joining the fight. B/A donates a portion of each purchase to Breast Cancer Research & Awareness.



TOWING STRAPS

<i>Strap Kits</i>	29
<i>V-Straps</i>	32
<i>Carrier Straps</i>	35
<i>Carrier Basket Straps</i>	37
<i>Wheel Lift Straps</i>	38
<i>Axle Straps</i>	41
<i>Underlift Straps</i>	41
<i>Steering Wheel Straps</i>	42
<i>Ratchets & Attachments</i>	43
<i>Round Slings</i>	46
<i>Recovery & Lifting</i>	48
<i>Accessories</i>	50
<i>Cargo Straps</i>	51
<i>Wreckmaster</i>	52

2" Roll Back Tie-Down System

Includes (12) Pieces:
 (4) Straps with Chain
 (4) Ratchets with Chain
 (4) Sewn Eye Short Straps

PART #	LENGTH	PART #	LENGTH
38-200C	14'	V38-200C	14'
38-218C	18'	V38-218C	18'
HV38-200C	14'	39-200C	14'
HV38-218C	18'	39-218C	18'

WLL 4,000 lb



2" Roll Back Tie-Down System

Includes (12) Pieces:
 (4) Straps with Snap Hook
 (4) Ratchets with Chain
 (4) Sewn Eye Short Straps

PART #	LENGTH	WLL
38-200	14'	4,000 lb
HV38-200	14'	4,000 lb
HV38-218	18'	4,000 lb



2" Roll Back Tie-Down System

Includes (12) Pieces:
 (4) Straps with Chain
 (4) Gradual Release Ratchets with Chain
 (4) Sewn Eye Short Straps

PART #	LENGTH	WLL
38-8200C	14'	4,000 lb
38-8218C	18'	4,000 lb
CURE38-8200C	14'	4,000 lb
CURE38-8218C	18'	4,000 lb



2" Roll Back Tie-Down System

Includes (14) Pieces:
 (4) Straps with Snap Hook
 (4) Ratchets with Chain
 (4) Sewn Eye Short Straps
 (2) Bolt-On D-Rings

PART #	LENGTH	WLL
38-200D	14'	4,000 lb



2" Roll Back Tie-Down System

Includes (12) Pieces:

- (4) Straps with Snap Hook
- (4) Ratchets with Snap Hook
- (4) Sewn Eye Short Straps

	PART #	LENGTH	WLL
(B/A)	38-200SH	14'	4,000 lb
(B/A)	38-218SH	18'	4,000 lb



x4

2" Tie-Down Kit

Includes (2) Pieces:

- (1) Straps with D-Ring
- (1) Ratchet with Finger Hook

	PART #	LENGTH	WLL
(B/A)	38-KIT110A	8'	1,000 lb



x1

2" Tie-Down Kit

Includes (8) Pieces:

- (4) Ratchets with Snap Hook
- (4) Straps with R, T & Mini J Cluster

	PART #	LENGTH	WLL
(B/A)	38-KIT122	8'	2,000 lb



x4

2" Tie-Down Kit

Includes (8) Pieces:

- (4) Ratchets with Chain
- (4) Straps with R, T & Mini J Cluster

	PART #	LENGTH	WLL
(B/A)	38-KIT100	8'	4,000 lb
(TE)	V38-KIT100	8'	4,000 lb
(HD)	39-KIT100	8'	4,000 lb



x4

2" Soft Tie-Down Kit

Includes (16) Pieces:

- (4) Straps with Snap Hook
- (4) 1-Ply Axle Straps with Delta Rings
- (4) Ratchets with Chain
- (4) Protective Sleeves

PART #	LENGTH	WLL
38-KITA36	36"	3,330 lb

B/A



x4

2" Soft Tie-Down Kit

Includes (12) Pieces:

- (4) Straps with D-Ring
- (4) Ratchets with Chain
- (4) Protective Sleeves

PART #	LENGTH	WLL
38-KITD12	12"	3,330 lb

B/A



x4

2" Soft Tie-Down Kit

Includes (16) Pieces:

- (4) Straps with Snap Hook
- (4) 1-Ply Axle Straps with Delta Rings
- (4) Ratchets with Snap Hook
- (4) Protective Sleeves

PART #	LENGTH	WLL
38-KITA3622	36"	3,330 lb

B/A



x4

Spreader Bar Vehicle Lifting Strap

(4) Straps with 4 Loops, Protective Sleeve, Oblong Link, Container Link, G80 Chain with Twist Lock™ Grab Hook on One End

PART #	SIZE	LENGTH	WLL
38-LL8450KIT	1/4"	3'	3,330 lb



Created in collaboration with tow professionals, this kit provides a fast and secure solution for lifting a vehicle weighing up to 13,320 lbs. Also known as 'Latta Loops,' there are multiple ways to attach to the casualty using terminal connections. The straps use 36" of 1/4" Grade 80 chain on one end to pass through the small holes vehicle wheels and connect back to our exclusive Twist Lock™ Grab Hook.

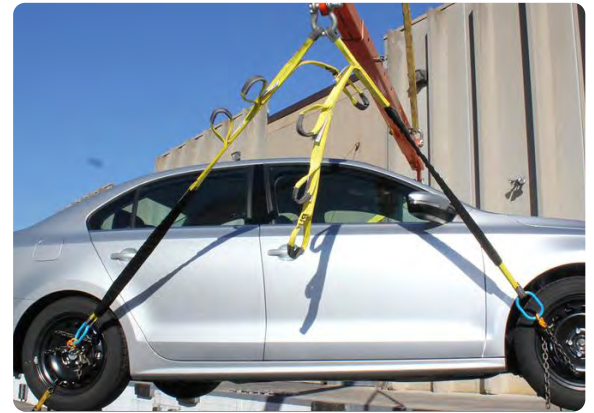

Bus Lift Strap



Includes (4) Straps.

- (2) 3" Strap with Snap Hook
- (2) 1" Blue Strap with Ratchet

PART #	LENGTH	WLL
38-B50	10'	3,330 lb

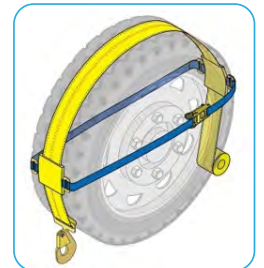
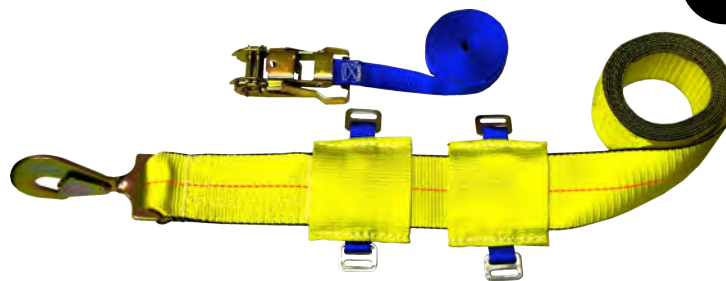

UP NEXT! THE LOW PROFILE ADVANTAGE

Reduce damage to the under carriage of vehicles with the patented Low Profile V-Bridles.

The hook of the winch line is now in a horizontal plane, with the tip of the hook pointed away from components that could damage new vehicle designs. This reduces the risk of puncturing the vehicles' oil pan, transmission, valance, bumper, radiator, etc. V-Bridles work best with Swivel Hook style rope assemblies.



Axle V-Strap

PART #	LENGTH
--------	--------



V11-VAS4	4'
— WLL 4,700 lb —	

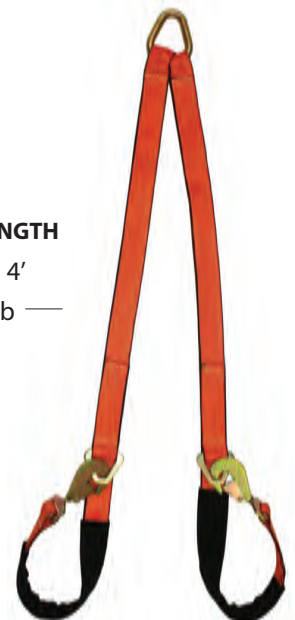

LOW-PROFILE V-STRAPS

Reduce chance of damage to the under carriage of vehicles.



Low Profile V-Strap with 8" J Hooks

PART #	LENGTH	WLL
LP11-8C	2'	5,400 lb
LP11-8C30	2 1/2'	5,400 lb



Low Profile V-Strap with 15" J Hooks

PART #	LENGTH	WLL
LP11-8CL	2'	5,400 lb
LP11-8CL30	2 1/2'	5,400 lb



Low Profile V-Strap with 8" J Hooks & T Hooks

PART #	LENGTH	WLL
LP11-8FCT	2'	5,400 lb



Low Profile V-Strap with 15" J Hooks & T Hooks

PART #	LENGTH	WLL
LP11-8CLT	2'	5,400 lb
LP11-8CLT30	2 1/2'	5,400 lb



Low Profile V-Strap with 8" J Hooks & Hammerhead® T-J Combo Hooks

PART #	LENGTH	WLL
LP11-8FCH	2'	5,400 lb
LP11-8FCH30	2 1/2'	5,400 lb



Low Profile V-Strap with 15" J Hooks & Hammerhead T-J Combo Hooks

PART #	LENGTH	WLL
LP11-8CLH	2'	5,400 lb

PATENTED



Low Profile V-Strap
with 8" J Hooks & Mini J Hooks

PART #	LENGTH	WLL
LP11-8CJ	2'	5,400 lb
LP11-8CJ30	2 1/2'	5,400 lb

PATENTED



Low Profile V-Strap with 15" J Hooks,
T Hooks & Mini J Hooks

PART #	LENGTH	WLL
LP11-8CLTJ	2'	5,400 lb

PATENTED



Low Profile V-Strap
with R, T & Mini J Hooks

PART #	LENGTH	WLL
LP11-8CLU	2'	5,400 lb
LP11-8CLU30	2 1/2'	5,400 lb
LP11-8CLU36	3'	5,400 lb
LP11-8CLU72	6'	5,400 lb

PATENTED



Low Profile Adjustable V-Strap
with R, T & Mini J Hooks

PART #	LENGTH	WLL
LP11-AV-WP	3'	5,400 lb

PATENTED



Low Profile V-Strap
for Exotic Vehicles

PART #	LENGTH	WLL
LP11-EC44	4' 4"	4,700 lb
HVLP11-EC44	4' 4"	4,700 lb



PATENTED



Low Profile Axle V-Strap



PART #	LENGTH	WLL
LP11-VAS4	4'	4,700 lb
LP11-VAS6	6'	4,700 lb

2" Sewn-Eye Short Strap for 8-Point Tie-Down System

PART #	LENGTH	WLL
 38-200-S	16"	4,000 lb
 HV38-200-S	16"	4,000 lb
 39-200-S	16"	4,000 lb



2" Strap with Mini J Hook

PART #	LENGTH	WLL
 38-5J	8'	4,000 lb
 V38-5J	8'	4,000 lb
 39-5J	8'	4,000 lb



2" Strap with Snap Hook

PART #	LENGTH	WLL
 38-200-L	14'	4,000 lb



2" Strap with Hammerhead® T-J Combo Hook

PART #	LENGTH	WLL
 38-5H	8'	4,000 lb





2" Strap with Twisted Snap Hook

PART #	LENGTH	WLL
 38-8	8'	3,670 lb



2" Strap with Chain

PART #	LENGTH	WLL
 38-200C-L	14'	4,000 lb
 38-218C-L	18'	4,000 lb



2" Chain Strap with Grab Hook

PART # LENGTH WLL

B/A 38-200C-LG 14' 4,000 lb



2" Tie-Down Strap with Mini J, R & T Hooks

PART # LENGTH PART # LENGTH

B/A 38-100-S 8' **HV** HV38-100-S 8'

B/A 38-100-S10 10' **HD** 39-100-S 8'

B/A 38-100-S12 12' **TE** V38-100-S10 10'

WLL 4,000 lb



2" Cluster Tie-Down

with Mini J, R & T Hooks & Chain Ratchet

PART # LENGTH WLL

B/A 38-100 8' 4,000 lb

HV HV38-100 8' 4,000 lb

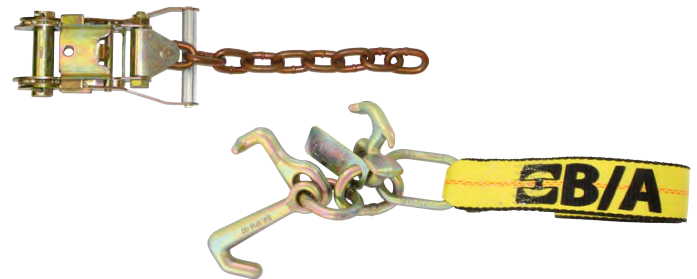

2" Tie-Down Strap

with Mini J, R & T Hooks & Gradual Release Chain Ratchet

PART # LENGTH WLL

B/A 38-8100 8' 4,000 lb

TC CURE38-8100 8' 4,000 lb



Towing for a Cure

B/A began the Towing for a Cure initiative in 2014 to support finding a cure for Breast Cancer. Using the same classic webbing dyed a bright pink and stenciled Towing for a Cure, our industry joined the fight. B/A donates a portion of each purchase to Breast Cancer Research & Awareness. B/A employees participating in the annual Susan G. Komen race for a cure, shown right.





Did you know?

In one year, B/A goes through more than 14 million feet of thread?! That's enough to reach from Baltimore, MD to San Francisco, CA, and then some!



Available as basket only or basket and ratchet combo

2" Tie-Down Basket Strap with D-Ring & Protective Sleeve

PART #	DESC	WLL
B/A 38-B19	Basket Only	3,330 lb
B/A 38-B19R	Basket w/Ratchet	3,330 lb



2" Side Rail Ratchet Tie-Down Assembly with Flat Hooks

PART #	WLL
B/A 38-65A	3,330 lb

2" Through The Wheel Strap

PART #	LENGTH	WLL
B/A 38-HL9	9'	1,655 lb

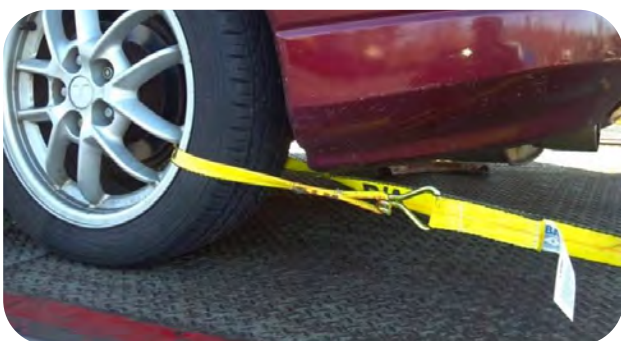



1" Vinyl Coated Basket Strap
with 1 Cross Straps & 2 T Hooks

PART #	WLL
38-61	1,500 lb



2" Basket Strap
with 3 Cross Straps & 2 T Hooks

PART #	WLL
38-62C	2,000 lb



2" Large Basket Strap
with 3 Cross Straps & 3 T Hooks

PART #	WLL
38-62CL3	2,000 lb

ALL BASKET STRAPS MADE TO OEM SPECIFICATIONS



2" Basket Strap
with Flat Snap Hook

PART #	WLL
38-6J	2,000 lb







2" Jerr-Dan Short Basket Strap
for Medium Duty Trucks

PART #	WLL
38-JD3	2,000 lb



2" 2-Piece Quick Pick Strap
with Flat Hook

	PART #	LENGTH	WLL
	38-JD5	10'	3,000 lb
	HV38-JD5	10'	3,000 lb
	V38-JD5	10'	3,000 lb
	39-JD5	10'	3,000 lb

2" Wheel Lift Strap with Double J Hook

PART #	LENGTH	WLL
B/A 38-4	8'	1,665 lb



2" Quick Pick Strap - Old Style

PART #	LENGTH	WLL
B/A 38-JD400	8'	1,000 lb



2" Wheel Lift Strap with D Ring

PART #	LENGTH	PART #	LENGTH
B/A 38-1	8'	TE V38-1	8'
B/A 38-1-10	10'	TE V38-1-10	10'
B/A 38-1-12	12'	HD 39-1	8'
B/A 38-1-14	14'	TC CURE38-1	8'
HV HV38-1	8'		WLL 3,330 lb



2" Wheel Lift Strap with Grab Plate

PART #	LENGTH	WLL
B/A 38-1A	8'	4,000 lb
TE V38-1A	8'	4,000 lb



2" Wheel Lift Strap with Snap Hook & Protective Sleeve

PART #	LENGTH	PART #	LENGTH
B/A 38-3D	8'	HD 39-3D	8'
HV HV38-3D	8'	TC CURE38-3D	8'
TE V38-3D	8'		WLL 2,000 lb



1 3/4" Wheel Lift Strap

with Flat Snap Hook, Large D Ring & Protective Sleeve

PART #	LENGTH	WLL
B/A 38-3	8'	2,000 lb



2" Wheel Lift Strap with Sewn Loop

PART #	LENGTH	WLL
B/A 38-5	8'	4,000 lb

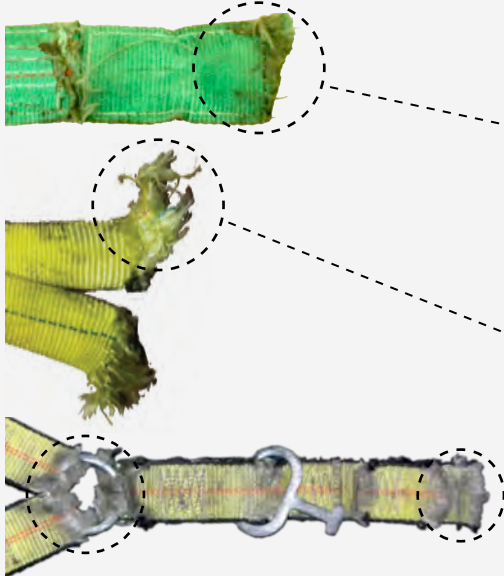

COMMON WEB FAILURES

CUTS

Even what seems like a smooth edge can cut through webbing when the web is under tension and the vibration of a vehicle going down the road is introduced. Signs of being cut are that all, or most, of the web fibers are the same length with minor fraying.

OVERLOADS

This strap was overloaded. The fibers have frayed more and the ends are not in a straight line.

ABRASION

This strap shows signs of abrasion, most likely by being dragged on the ground. It is unlikely this strap would support its rated Work Load Limit.

NEVER

Tie-Downs:

- Exceed the Work Load Limit of the tie-down.
- Shock load a tie-down.
- Use tie downs to lift, lower or suspend cargo.
- Tie knots in tie-downs for any reason.
- Use web in temperatures over 194° F or under -40° F, or allow web to come into contact with objects above or below these temperatures.
- Pull tie-downs from under cargo or drop and/or drag tie-downs on any abrasive surface.

Slings:

- Exceed the Work Load Limit of the sling.
- Shock load a sling.
- Use a lifting sling that has been previously used to tow or pull cargo, for lifting. Such slings should be marked "for towing only."
- Tie knots in slings.
- Pull slings from under cargo or drag slings on abrasive surfaces.
- Use web in temperatures over 194° F or under -40° F, or allow web to come into contact with objects above or below these temperatures.

VISIT: BAPROD.COM

for more Specs & Usage

ALWAYS

Tie-Downs:

- Protect the web from corners, edges, abrasive surfaces and protrusions with sleeves or padding designed to protect the web from being cut or abraded.
- Verify the anchor points are rated equal to or greater than the Tie-Down. If anchor points are rated lower, the Tie-Down must be derated.
- Use Tie-Downs in accordance with Federal Motor Carrier Safety Administration and Commercial Vehicle Safety Alliance procedures and practices.
- Web sites: www.fmcsa.dot.gov, www.cvsa.org
- Inspect Before Each Use

Slings:

- Use accepted rigging procedures. If unsure of procedures DO NOT attempt to rig or lift until a Qualified person is present and approves the procedure.
- Load hooks of fittings in the bowl of the hook, NEVER tip load.
- Protect the sling from corners, edges, abrasive surfaces and protrusions with sleeves or padding designed to protect the web from being cut or abraded.
- Load sling eyes so they are flat in shackles or hooks.
- Know the effect of the Sling Angle on Sling Capacity.
- Consider environmental factors when selecting slings.
- Know the three hitch types.
- Inspect Before Each Use

1-Ply 2" Axle Strap with Delta Rings & Protective Sleeve

PART #	LENGTH	WLL
38-57-20WP	20"	3,330 lb
38-57-36WP	36"	3,330 lb



3-Ply 2" Axle Strap with D Rings

PART #	LENGTH	WLL
38-50-26	26"	3,330 lb
38-50-36	36"	3,330 lb
38-50-48	48"	3,330 lb



2" Medium Duty Underlift Tie-Down with Flat Hook & Protective Sleeve

PART #	LENGTH	WLL
38-105FH	66"	7,000 lb



2" Medium Duty Underlift Tie-Down with Ratchet & Protective Sleeve

PART #	LENGTH	WLL	UNIT
38-104	66"	7,000 lb	PAIR
V38-104	66"	7,000 lb	PAIR



Heavy Duty Underlift Tie-Down with Ratchet & Protective Sleeve

PART #	HANDLE	SIZE	LENGTH	WLL	UNIT
38-104HD	Wide	2"	76"	7,300 lb	PAIR
38-106	Long Wide	3"	64"	11,000 lb	PAIR
38-106-S	Long Wide	3"	64"	11,000 lb	EA
38-106-4	Wide	4"	64"	16,000 lb	PAIR



3" Heavy Duty Underlift Tie-Down with Short Handle Ratchet

PART #	DESCRIPTION	LENGTH	WLL	UNIT
38-107	Protective Sleeve	64"	11,000 lb	PAIR
38-107P	Strap Protector	64"	11,000 lb	PAIR





Nylon One Hook Steering Wheel Lock

PART #	DESCRIPTION	SIZE	WLL
8-31	Cam-Lock	2"	1,000 lb



Nylon Claw Hook Steering Wheel Lock

PART #	DESCRIPTION	SIZE	WLL
8-34CH	Cam-Lock	2"	830 lb
8-R34CH	Ratchet	2"	830 lb



IMPORTANT INFORMATION ABOUT OUR WEBBING

Unless specified differently, all B/A Products Co. web products are made with polyester web. Polyester web stretches less than nylon and is denser than nylon, allowing a polyester strap to be thinner than a nylon strap of the same Work Load Limit. Polyester also has better moisture and acid resistance. Polyester should never be used where alkalis are present.

GENERAL WEB USAGE

All assemblies sewn by B/A Products Co. have a tag which identifies the material and the Work Load Limit of the assembly.

When not in-use, web assemblies should be stored in a cool, dry, dark place. Web assemblies should be cleaned with plain water only, and never machine washed. Visit BAPROD.COM for more information on specs & usage.



2" Ratchet

PART #	HANDLE	WLL
38-10	Standard	4,000 lb
38-20	Wide	4,000 lb
38-80	Gradual Release	4,000 lb

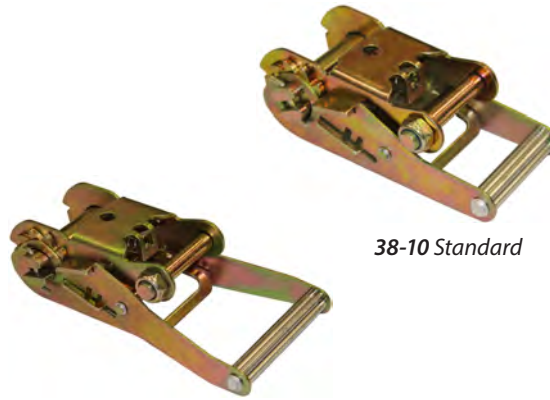

38-10 Standard



38-20 Wide



38-80 Gradual Release

2" Ratchet with Chain

PART #	HANDLE	WLL
38-70R	Long Wide	4,000 lb
38-100-R	Wide	4,000 lb
38-8100-R	Gradual Release	4,000 lb



38-70R Long Wide



38-100-R Wide



38-8100-R Gradual Release

MEETS OR EXCEEDS OEM SPECIFICATIONS

2" Ratchet with Double J Hook

PART #	HANDLE	WLL
38-10C	Regular	1,665 lb
38-20C	Wide	1,665 lb
38-80C	Gradual Release	1,665 lb



38-10C Regular



38-20C Wide



38-80C Gradual Release

2" Ratchet with Forged Finger Hook

PART #	HANDLE	WLL
38-17	Regular	2,570 lb
38-27	Wide	2,570 lb
38-87	Gradual Release	2,570 lb



38-17 Regular



38-27 Wide



38-87 Gradual Release

2" Ratchet with Finger Hook

PART #	HANDLE	WLL
38-10A	Regular	1,000 lb
38-20A	Wide	1,000 lb
38-70A	Long Wide	2,000 lb
38-80A	Gradual Release	1,000 lb



38-10A Regular



38-70A Long Wide



38-20A Wide



38-80A Gradual Release

2" Ratchet with Snap Hook

PART #	HANDLE	WLL
38-12	Regular	2,000 lb
38-22	Wide	2,000 lb
38-72	Long Wide	2,000 lb
38-82	Gradual Release	2,000 lb

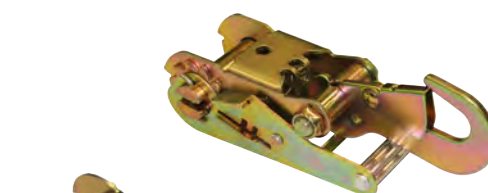

38-12 Regular



38-72 Long Wide

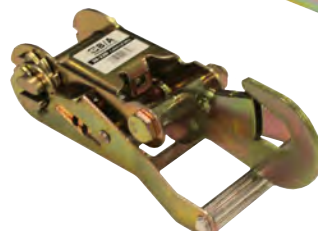

38-22 Wide



38-82 Gradual Release

MEETS OR EXCEEDS OEM SPECIFICATIONS

2" Ratchet with Bent Finger Hook

PART #	HANDLE	WLL
38-10F	Regular	2,000 lb
38-20F	Wide	2,000 lb
38-80F	Gradual Release	2,000 lb



38-10F Regular



38-20F Wide



38-80F Gradual Release



NEW GRADUAL RELEASE HANDLE

Features & Benefits

- Easy to use Ratchet with comfort rubber grip handle
- Step-by-step controlled gradual release action reduces the risk of accidents
- Stamped with WLL for easy identification

Ratchets & Fittings meet or exceed OEM Specifications and offer a patented double locking mechanism.

2" Ratchet
with Forged Swivel J Hook

PART #	HANDLE	WLL
38-20SJ1	Wide	3,670 lb



2" Ratchet
with Chain & Clevis Grab Hook

PART #	HANDLE	WLL
38-100-RG	Wide	4000 lb



3" Ratchet

PART #	HANDLE	WLL
38-30S	Short	7330 lb



RATCHET ATTACHMENTS



Finger Hook

PART #	WLL
38-10A-H	1,000 lb



Forged Finger Hook

PART #	WLL
38-17-H	2,570 lb



Bent Finger Hook

PART #	WLL
38-10F-H	2,000 lb



Double J Hook

PART #	WLL
38-10C-H	1,665 lb



Chain with U Bracket and Pins

PART #	WLL
38-100R-H	4,000 lb



Snap Hook with Spacers

PART #	WLL
38-12-H	2,000 lb

1" Purple Round Slings

PART #	LENGTH	WORKING LOAD LIMIT		
		VERTICAL	CHOKER	BASKET
38-RSP-4	4'			
38-RSP-6	6'	2,600 lb	2,100 lb	5,200 lb
38-RSP-8	8'			



2" Green Round Slings

PART #	LENGTH	WORKING LOAD LIMIT		
		VERTICAL	CHOKER	BASKET
38-RSG-4	4'			
38-RSG-6	6'	5,300 lb	4,200 lb	10,600 lb
38-RSG-8	8'			
38-RSG-10	10'			
38-RSG-12	12'			

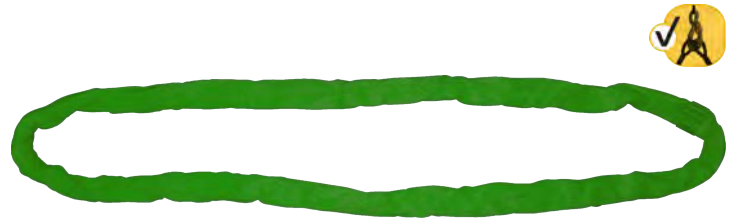

3" Yellow Round Slings

PART #	LENGTH	WORKING LOAD LIMIT		
		VERTICAL	CHOKER	BASKET
38-RSY-4	4'			
38-RSY-6	6'	8,400 lb	6,700 lb	16,800 lb
38-RSY-8	8'			
38-RSY-10	10'			
38-RSY-12	12'			

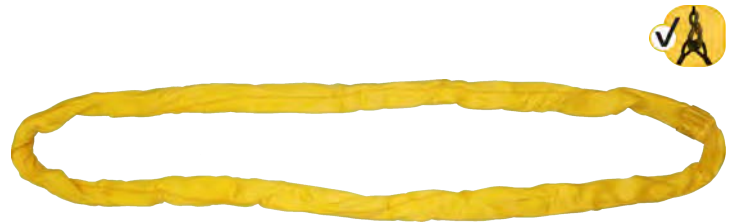

5" Red Round Slings

PART #	LENGTH	WORKING LOAD LIMIT		
		VERTICAL	CHOKER	BASKET
38-RSR-6	6'			
38-RSR-8	8'	13,200 lb	10,600 lb	26,400 lb
38-RSR-10	10'			
38-RSR-12	12'			



7" Blue Round Slings

PART #	LENGTH	WORKING LOAD LIMIT		
		VERTICAL	CHOKER	BASKET
38-RSB-6	6'			
38-RSB-8	8'	21,200 lb	17,000 lb	42,400 lb
38-RSB-10	10'			
38-RSB-12	12'			
38-RSB-16	16'			
38-RSB-20	20'			



10" Orange Round Slings

PART #	LENGTH	WORKING LOAD LIMIT		
		VERTICAL	CHOKER	BASKET
38-ENR10-5	5'			
38-ENR10-8	8'	40,000 lb	32,000 lb	80,000 lb
38-ENR10-10	10'			
38-ENR10-12	12'			
38-ENR10-16	16'			
38-ENR10-20	20'			

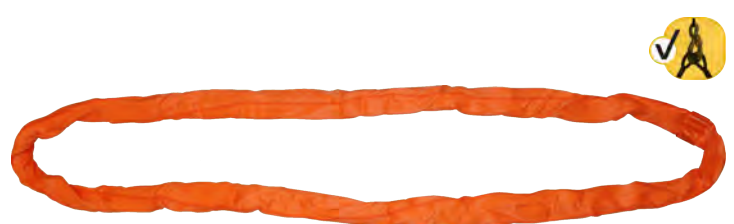

Round slings are color coded for the different capacities to be more convenient when you need to make a fast decision on the job.

STRAP

Round Slings

Round Sling Kit

Includes (12) Pieces:
 (4) Green 4'
 (4) Round Sling Hooks
 (4) Protective Sleeves



Sling Hooks x4

To pass through rims of larger vehicles creating a terminal connection.



Protective Sleeves x4

This Round Sling Kit works well with the Spreader Bar Vehicle Lifting Strap (aka Latta Loops) shown on page 34

WLL

PART #	DESCRIPTION	CHOKER	
38-LLRK	Round Sling Hook	4,200 lb 5,300 lb	

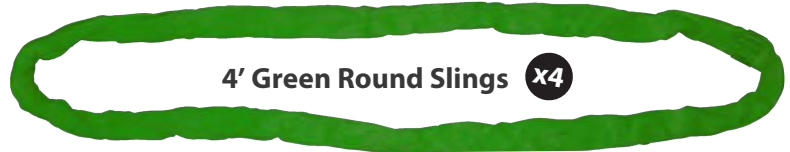

4' Green Round Slings x4

Round Sling Kit

(2) Yellow 4' (2) Red 8' (2) Blue 12'
 (2) Yellow 6' (2) Red 12' (2) Blue 16'



WORKING LOAD LIMIT

PART #	COLOR	VERTICAL	BASKET	CHOKER
38-RSK	Blue	21,200 lb	42,400 lb	17,000 lb
	Red	13,200 lb	26,400 lb	10,600 lb
	Yellow	8,400 lb	16,800 lb	6,700 lb

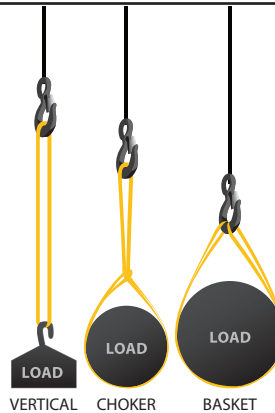

4' Yellow x2

6' Yellow x2

8' Red x2

12' Red x2

12' Blue x2

16' Blue x2



INSPECT ROUND SLINGS REGULARLY & REMOVE ROUND SLING FROM SERVICE IF ANY OF THE FOLLOWING FORMS OF DAMAGE IS VISIBLE:

- Holes, tears, cuts, embedded particles, excessive abrasive wear, or snags that expose the core fibers of the round sling
- If core yarn has been broken or damaged or there is any evidence of a broken core yarn(s)
- If round sling identification tag is missing or not readable
- If round sling has been tied into one or more knots or has been joined by knotting
- Melting, charring or weld spatter of any part of the round sling
- Acid or alkali burns of the round sling
- Broken or worn stitching in the cover which exposes the core fibers
- Distortion, excessive pitting, corrosion or other damage to fitting(s)
- Any conditions which cause doubt as to the strength of the round sling

EXAMPLES OF DAMAGE



EYE & EYE Synthetic Super Sling



WORKING LOAD LIMIT

PART #	SIZE	LENGTH	VERTICAL	BASKET	CHOKER
● 4R2-1206	1/2"	6'	6,120 lb	12,240 lb	5,200 lb
● 4R2-1208	1/2"	8'	6,120 lb	12,240 lb	5,200 lb
● 4R2-5808	5/8"	8'	9,450 lb	18,900 lb	8,030 lb
● 4R2-3408	3/4"	8'	11,880 lb	23,760 lb	10,100 lb
● 4R2-3410	3/4"	10'	11,880 lb	23,760 lb	10,100 lb

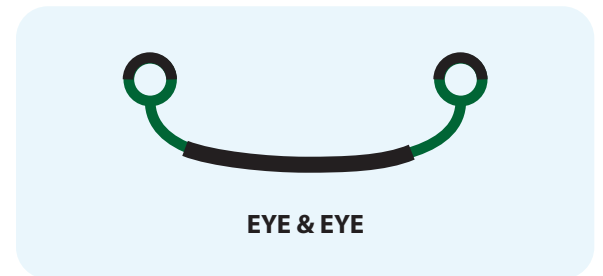

B/A Verifies WLL by Break Testing & Uses Minimum Break Strength Rather Than Average Break Strength

ENDLESS Synthetic Super Sling



WORKING LOAD LIMIT

PART #	SIZE	LENGTH	VERTICAL	BASKET	CHOKER
● 4R1-3804	3/8"	4'	7,020 lb	14,040 lb	5,970 lb
● 4R1-3806	3/8"	6'	7,020 lb	14,040 lb	5,970 lb
● 4R1-3808	3/8"	8'	7,020 lb	14,040 lb	5,970 lb
● 4R1-1206	1/2"	6'	12,240 lb	24,480 lb	10,400 lb
● 4R1-1208	1/2"	8'	12,240 lb	24,480 lb	10,400 lb
● 4R1-5808	5/8"	8'	18,900 lb	37,800 lb	16,065 lb
● 4R1-5810	5/8"	10'	18,900 lb	37,800 lb	16,065 lb
● 4R1-3408	3/4"	8'	23,760 lb	47,520 lb	20,200 lb
● 4R1-3410	3/4"	10'	23,760 lb	47,520 lb	20,200 lb

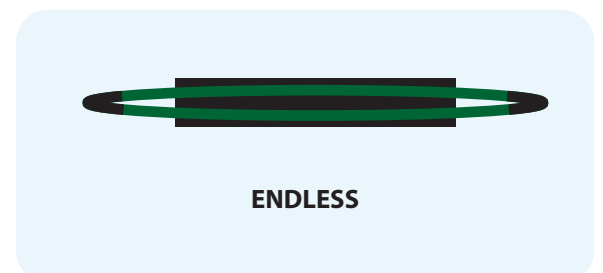
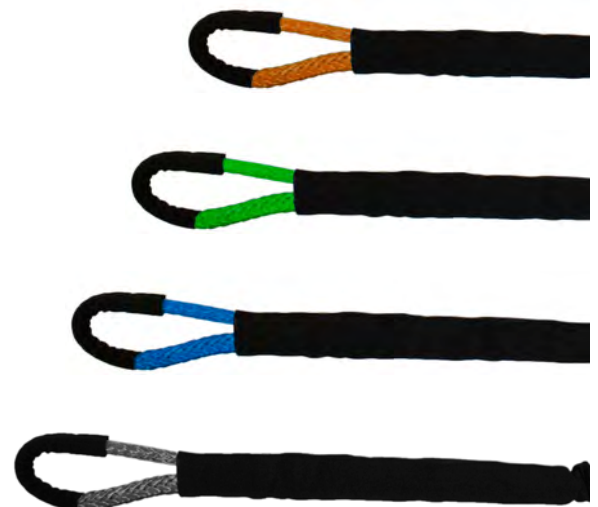

Recovery straps are made with heavy duty polyester, as well as tapered and lined eyes at hardware connection points.



1-Ply Recovery Strap

WORKING LOAD LIMIT

PART #	SIZE	LENGTH	VERTICAL	BASKET	CHOKER
9-12/20	12"	20'	17,600	14,080	35,200
9-12/26	12"	26'	17,600	14,080	35,200

— For Overhead Lifting —



2-Ply Recovery Strap

WORKING LOAD LIMIT

PART #	SIZE	LENGTH	VERTICAL	BASKET	CHOKER
9-2P6/16	6"	16'	16,500	13,200	33,000
9-2P6/26	6"	26'	16,500	13,200	33,000
9-2P8/20	8"	20'	22,700	18,160	45,400
9-2P8/26	8"	26'	22,700	18,160	45,400
9-2P8/40I30	8"	30' - 40'	22,700	18,160	45,400
9-2P12/16	12"	16'	34,100	27,280	68,200
9-2P12/20	12"	20'	34,100	27,280	68,200
9-2P12/26	12"	26'	34,100	27,280	68,200

— For Overhead Lifting —



Did you know?

Recovery straps are the most complex to sew, using the most robust industrial needles, and requiring up to 4 people to use an entire day to sew one strap!



2-Ply Protective Wrapped Recovery Strap

The full width Protective Sleeve is sewn on for extra wear resistance and adds another safety layer for routine wear.

WORKING LOAD LIMIT

PART #	SIZE	LENGTH	VERTICAL	BASKET	CHOKER
9-DC8/20	8"	20'	22,700	18,160	45,400
9-DC12/16	12"	16'	34,100	27,280	68,200
9-DC12/20	12"	20'	34,100	27,280	68,200
9-DC12/26	12"	26'	34,100	27,280	68,200

— For Overhead Lifting —

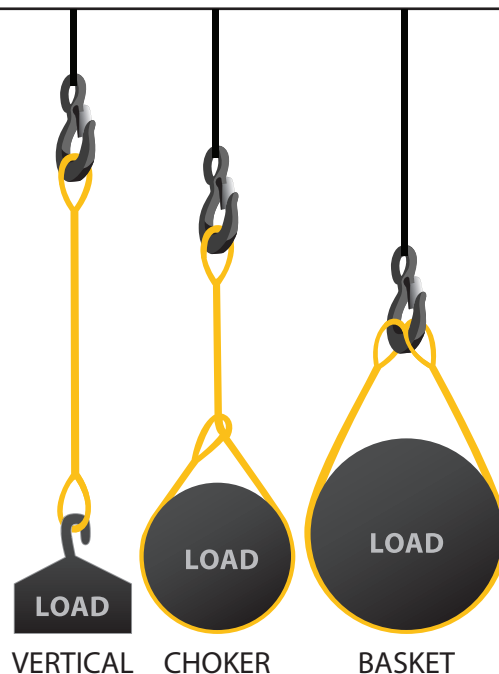

Quick Pin Web Shackle

These web shackles are one of the fastest way of connecting your web shackle to the eyes on your recovery straps.

PART #	SIZE	WLL
9-S6HD	6"	23,850 lb



Bolt Style Web Shackle

The safest way to connect a web shackle to a recovery strap. By adding the nut and bolt feature we have added peace of mind when using the web shackles for normal recovery or accidental side loads.

PART #	SIZE	WLL
9-W3	3"	13,000 lb
9-W4	4"	14,500 lb
9-W6	6"	22,500 lb



Cover Pad
with hook and loop enclosure

PART #	SIZE	LENGTH
9-12-PAD	12"	24"

Steel Triangles

PART #	SIZE	WLL
9-ST12	12"	32,000 lb

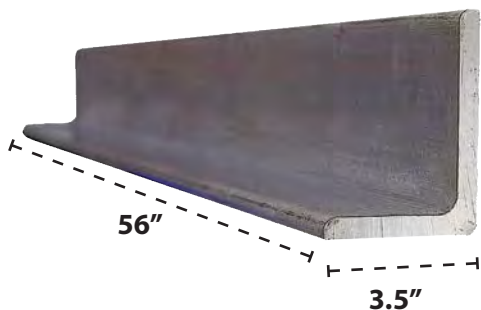
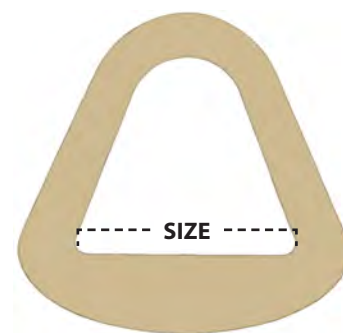

Aluminum Angle

PART #	LENGTH	DEPTH
45-1	56"	3.5"



Guardian Angle™

PART #	LENGTH
45-3A24	24"
45-3B42	42"



Ratchet Strap with Double J Hooks

PART #	SIZE	LENGTH	WLL
TD2-15DJ	2"	15'	3,300 lb
TD2-20DJ	2"	20'	3,300 lb
TD2-27DJ	2"	27'	3,300 lb
TD2-30DJ	2"	30'	3,300 lb



Ratchet Strap with S Hooks

PART #	SIZE	LENGTH	WLL
TD1-R6S	1"	6'	1,000 lb
TD1-R8S	1"	8'	1,000 lb
TD1-R10S	1"	10'	1,000 lb
TD1-R12S	1"	12'	1,000 lb
TD1-R16S	1"	16'	1,000 lb



Ratchet Strap with Double J Hooks & D Rings

PART #	SIZE	LENGTH	WLL
TD1-R16DJ	1"	16'	1,000 lb



Ratchet Strap with Flat Hooks

PART #	SIZE	LENGTH	WLL
TD2-27FF	2"	27'	3,300 lb
TD2-30FF	2"	30'	3,300 lb
TD4-30FF	4"	30'	5,400 lb



Ratchet Strap with Chain & Grab Hooks

PART #	SIZE	LENGTH	WLL
TD2-27CG	2"	27'	3,300 lb
TD2-30CG	2"	30'	3,300 lb



Flat Hook Strap

PART #	SIZE	LENGTH	WLL
TD4-30F	4"	30'	5,400 lb



Ultra Heavy Duty Recovery Equipment Package

- (2) 8" x 36' 2-Ply Recovery Straps (1) 1' Super Wrinkle
 (4) 5" Bolt Style Web Shackles (1) Heavy Duty DVD
 (4) 10' x 30' Slide On Wear Pads

WORKING LOAD LIMIT

PART #	UNIT	CHOKER	VERTICAL	BASKET
WM-701025	KIT	15,400 lb	19,200 lb	38,400 lb

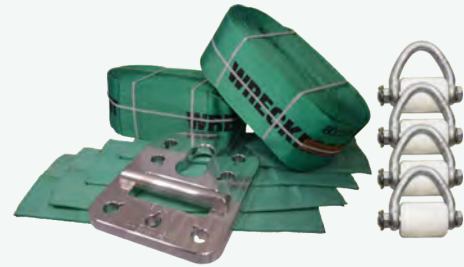

Ultra Heavy Duty Recovery Equipment Package

- (2) 6" x 36' 2-Ply Recovery Straps (1) 6" Buckle with Pin
 (4) 4" Bolt Style Web Shackles (1) Heavy Duty One Lane DVD
 (4) 8" x 30" Slide On Wear Pads

WORKING LOAD LIMIT

PART #	UNIT	CHOKER	VERTICAL	BASKET
WM-701026	KIT	13,000 lb	16,300 lb	32,600 lb



Cruse Loop Package

- (1) 4" x 30' Light Duty Recovery Straps (1) Tail Transformer
 (1) 4" Buckle (1) Heavy Duty DVD
 (1) 6" x 24" Slide On Wear Pads

WORKING LOAD LIMIT

PART #	UNIT	CHOKER	VERTICAL	BASKET
WM-701035	KIT	4,800 lb	6,400 lb	12,800 lb



Car Carrier Tie Down Package

- (4) Ratchets with 3/8" G70 Chain (4) 8-Point Straps
 (4) 15' Mini J, R & T Cluster Straps

WORKING LOAD LIMIT

PART #	UNIT	DESCRIPTION
WM-701045	KIT	Package
WM-801040	EA	Replacement Ratchet w/ Chain
WM-801033	EA	Replacement Cluster Strap

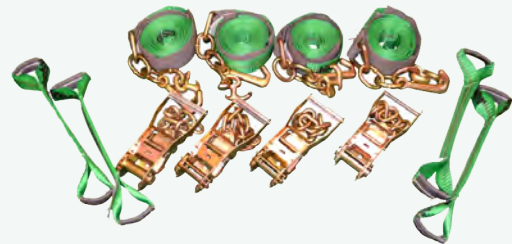

2" Strap with Chain & Mini J, R & T Hooks

PART #	LENGTH	WLL
WM-801034	18"	? lb

Buckle & Pin

PART #	SIZE	WLL
WM-701126	8"	50,000 lb



2" Wheel Lift Strap with D-Ring

PART #	LENGTH	WLL
WM-801044	?	? lb



V-Strap with Mini J, R & T Hooks

PART #	SIZE	WLL
WM-801043	2"	? lb

FIBER CORE WIRE ROPE

SUPER SWAGE WINCH LINE

STEEL CORE WIRE ROPE

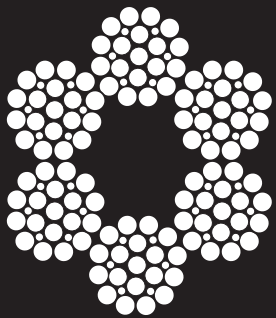

6 x 25

Extra Improved Plow
Steel Construction

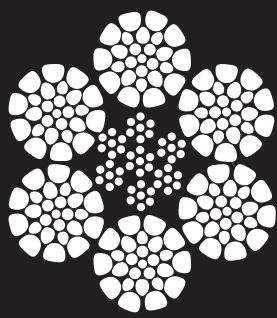

6 x 26

Extra Improved Plow
Steel Construction

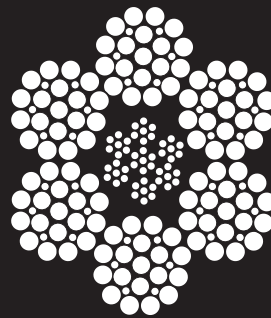

6 x 25

Extra Improved Plow
Steel Construction

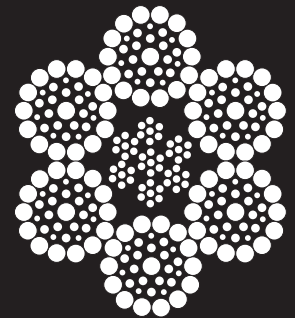

6 x 37

Extra Improved Plow
Steel Construction

*Natural or Synthetic
Polypropylene fibers
for greater elasticity.*

*Stronger, more
durable and resistant
to drum crushing
with a stainless steel
duplex sleeve.*

*For use when Fiber Core may
not provide adequate support
or operating environment has
temperatures that could exceed 180° F.*

3/8" - 5/8"
Wire Rope Assemblies

3/8" - 5/8"
Wire Rope Assemblies

3/8" - 5/8"
Wire Rope Assemblies

3/4"
Wire Rope Assemblies

TOWING WIRE ROPE

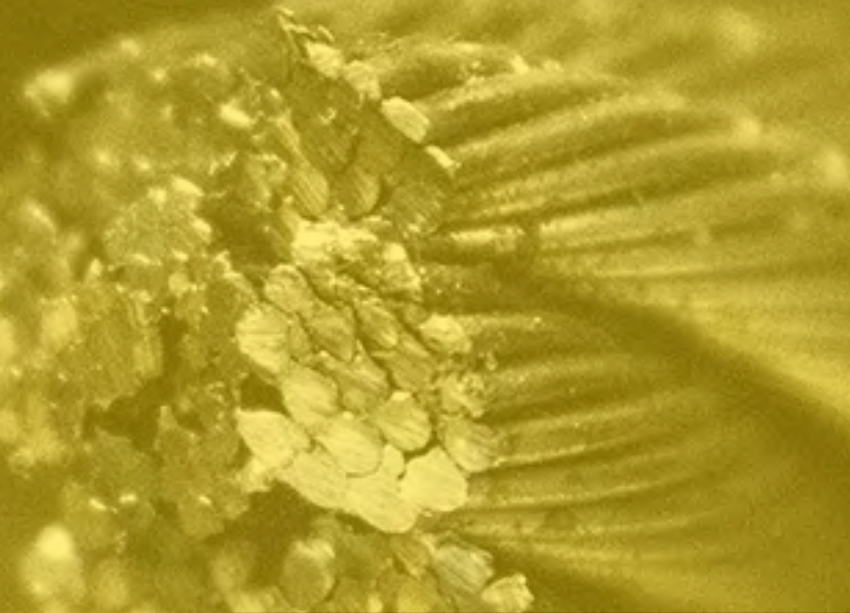

<i>Winch Line.....</i>	55
<i>Super Swaged.....</i>	57
<i>Synthetic Winch Line... </i>	58
<i>Snatch Blocks.....</i>	59
<i>Service Parts.....</i>	61
<i>Accessories.....</i>	61



ALLOY SWIVEL HOIST HOOK

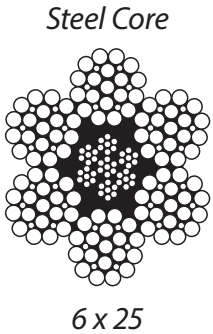

LENGTH	3/8"	7/16"	1/2"	5/8"	3/4"
50'	-	4-716SC50S	-	-	-
56'	4-38SC56S	-	-	-	-
75'	4-38SC75S	4-716SC75S	4-12SC75S	4-58SC75S	-
100'	4-38SC100S	4-716SC100S	4-12SC100S	4-58SC100S	-
150'	-	4-716SC150S	4-12SC150S	4-58SC150S	-
200'	-	-	-	4-58SC200S	4-34EI200S
250'	-	-	-	4-58SC250S	4-34EI250S
STEEL CORE	6 x 25	6 x 25	6 x 25	6 x 25	6 x 37
WLL @ 3.55:1	4,250 lb	5,740 lb	7,490 lb	11,600 lb	16,560 lb
MIN. BREAK STRENGTH	15,100 lb	20,400 lb	26,600 lb	41,200 lb	58,800 lb

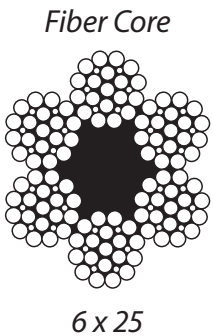

LENGTH	3/8"	7/16"
50'	-	4-716PS50S
56'	4-38PS56S	-
75'	4-38PS75S	4-716PS75S
100'	4-38PS100S	4-716PS100S
150'	-	4-716PS150S
STEEL CORE	6 x 25	6 x 25
WLL @ 3.55:1	3,780 lb	5,120 lb
MIN. BREAK STRENGTH	13,420 lb	18,200 lb

3/4" WIRE ROPE

The Steel Core 6 x 37 construction is manufactured with more strands providing greater flexibility for heavier loads.

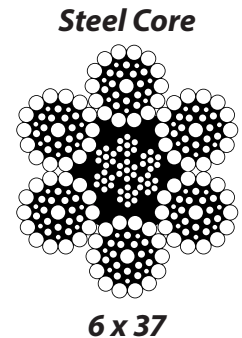

ALLOY EYE HOIST HOOK

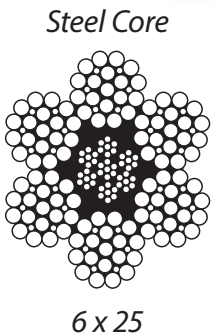

LENGTH	3/8"
100'	4-38SC100
STEEL CORE	6 x 25
WLL @ 3.55:1	4,250 lb
MIN. BREAK STRENGTH	15,100 lb

All B/A Wire Rope Assemblies are made with Extra Improved Plow Steel for Superior Strength & Flexibility

3/8" - 5/8" Wire Rope Assemblies
Manufactured with 6 x 25 Class

3/4" Wire Rope Assemblies
Manufactured with 6 x 37 Class

Assemblies are manufactured in our Columbia, Maryland warehouse.



SELF LOCKING SWIVEL HOOK

Steel Core

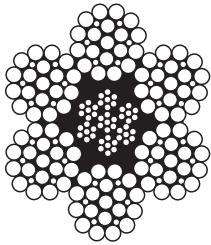

6 x 25

LENGTH	3/8"	7/16"	1/2"	5/8"	3/4"
50'	-	4-716SC50LH	-	-	-
56'	4-38SC56LH	-	-	-	-
75'	4-38SC75LH	4-716SC75LH	-	4-58SC75LH	-
100'	4-38SC100LH	4-716SC100LH	4-12SC100LH	-	-
150'	4-38SC150LH	4-716SC150LH	4-12SC150LH	-	-
200'	-	-	-	4-58SC200LH	4-34EI200LH
250'	-	-	-	4-58SC250LH	4-34EI250LH
STEEL CORE	6 x 25	6 x 25	6 x 25	6 x 25	6 x 37
WLL @ 3.55:1	4,250 lb	5,740 lb	7,490 lb	11,600 lb	16,560 lb
MIN. BREAK STRENGTH	15,100 lb	20,400 lb	26,600 lb	41,200 lb	58,800 lb

Fiber Core

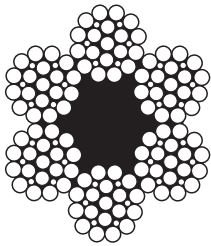

6 x 25

LENGTH	3/8"	7/16"
50'	-	4-716PS50LH
56'	4-38PS56LH	-
75'	4-38PS75LH	4-716PS75LH
100'	4-38PS100LH	4-716PS100LH
150'	4-38PS150LH	4-716PS150LH
STEEL CORE	6 x 25	6 x 25
WLL @ 3.55:1	3,780 lb	5,120 lb
MIN. BREAK STRENGTH	13,420 lb	18,200 lb

3/4" WIRE ROPE

The Steel Core 6 x 37 construction is manufactured with more strands providing greater flexibility for heavier loads.

Steel Core

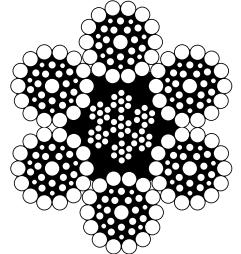

6 x 37



WIRE ROPE WINCH LINE TAGS

The general specifications, warnings & Working Load Limits are printed clearly on each tag for your safety and convenience. Please refer to our Specs & Usage Section, use the QR Code on the WLL tag to visit www.baproduct.com or give us a call at 800.327.3301 for more information about our Wire Rope Assemblies.

SPECS & USAGE

For Supporting Rating Loads (Including Boom Suspensions):
The Strength Factor for live or running ropes that wind on drums or pass over sheaves shall not be less than 3.55.

Please reference Section 7 Specifications & Usage and/or see the Society of Automotive Engineers Technical Standards for more information on Wire Rope. Spec: ASME / ANSI B30.5. Supersedes spec SAE-J959



Steel Core

Alloy Swivel Hoist Hook

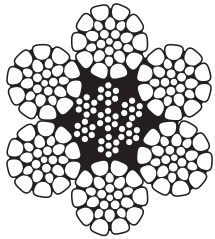

6 x 26

PART #	SIZE	LENGTH
4-S3856S	3/8"	56'
4-S3875S	3/8"	75'
4-S38100S	3/8"	100'
WLL @ 3.55:1		5,700 lb
MIN. BREAK STRENGTH		20,400 lb



Steel Core

Self Locking Hook

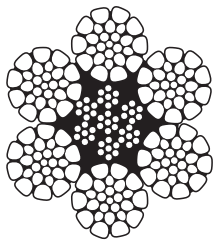

6 x 26

PART #	SIZE	LENGTH
4-S3856LH	3/8"	56'
4-S3875LH	3/8"	75'
4-S38100LH	3/8"	100'
4-S38125LH	3/8"	125'
4-S38150LH	3/8"	150'
4-S71650LH	7/16"	50'
4-S71675LH	7/16"	75'
4-S716100LH	7/16"	100'
3/8"		7/16"
WLL @ 3.55:1		5,700 lb 7,600 lb
MIN. BREAK STRENGTH		20,400 lb 27,200 lb

SUPER SWAGED WINCH LINE BENEFITS

STRONGER

Compact design allows for up to 26% greater strength than standard Winch Lines of the same diameter.

MORE DURABLE

Due to the swaging process, the outer wires have a larger surface area than standard Winch Lines, providing better resistance to abrasion, pig tailing & kinking.

STAINLESS STEEL DUPLEX SLEEVE

Precision cast internal hourglass shape maximizes sleeve to Wire Rope contact and cross sectional fill. Lip cover sharp wires in tail.

RESISTANCE TO DRUM CRUSHING

Because the Winch Line is already compacted during the swaging process, there is less space within the rope to compact if exposed to crushing.

CONSTRUCTION

6 x 26 IWRC. Available in 3/8" or 7/16" sizes with Alloy Swivel Hoist or Self Locking Hook.



NOMINAL STRENGTH $\frac{\bullet}{\bullet}$ DESIGN FACTOR
== WORK LOAD LIMIT



WIRE ROPE WILL FAIL IF IT IS:

- WORN OUT
- OVERLOADED
- MISUSED
- DAMAGED
- IMPROPERLY MAINTAINED

For more information on Specs & Usage please visit BAPROD.COM

High strength, abrasion resistant, low stretch, super tough/high wear, flexible, more torque/layer, low recoil

SAFETY

Should the Synthetic Rope break, the energy released is much less than Steel Cable because it's lighter and softer

LIGHTWEIGHT

Weighs 1/7th of Steel Cable, making it much easier to use and handle, especially where extensions may be needed.

FLOATS ON WATER

For those that do a lot of water recoveries, this property has a profound impact on safety and ease of use

SIZE COLOR CODED

We have created each size of Synthetic Rope with its own color, making it easy to identify size and WLL

SAFER ON HANDS

The Synthetic Rope is smooth with no burrs, reducing the change of cuts and injuries during usage

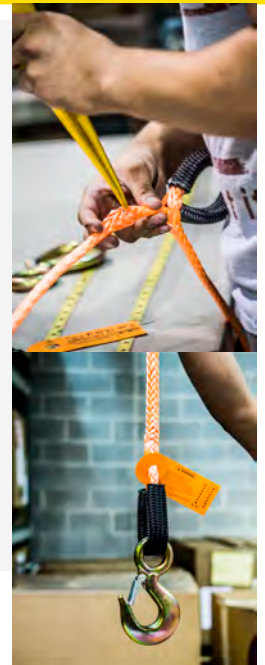

Winch Lines with Self Locking Hook

PART #	SIZE	LENGTH	WLL
● 4-R3850L	3/8"	50'	4,100 lb
● 4-R3875L	3/8"	75'	4,100 lb
● 4-R38100L	3/8"	100'	4,100 lb
● 4-R716100L	7/16"	100'	5,200 lb



Extensions with Self Locking Hook

PART #	SIZE	LENGTH	WLL
● 4-RE3850L	3/8"	50'	4,100 lb
● 4-RE3875L	3/8"	75'	4,100 lb
● 4-RE38100L	3/8"	100'	4,100 lb
● 4-RE71650L	7/16"	50'	5,200 lb



Synthetic Rope with Hoist Hook

PART #	DESCRIPTION	SIZE	LENGTH	WLL
● 4-R3850	Winch Line	3/8"	50'	4,100 lb
● 4-R38100	Winch Line	3/8"	100'	4,100 lb





with Latched Swivel Hooks

PART #	SHEAVE	FITS ROPE	WLL
6I-2T3	3"	5/16" - 3/8"	2T
6I-3T3	3"	5/16" - 3/8"	3T
6I-4T4	4 1/2"	3/8" - 1/2"	4T
6I-8T6	6"	5/8" - 3/4"	8T
6I-8T8	8"	5/8" - 3/4"	8T
6I-15T8	8"	3/4" - 7/8"	15T
6I-15T10	10"	3/4" - 7/8"	15T



with Swivel Shackles

PART #	SHEAVE	FITS ROPE	WLL
6I-SW2T	3"	5/16" - 3/8"	2T
6I-SW4T	4 1/2"	3/8" - 1/2"	4T



with Swivel Hooks & Heavy Duty Latches with Pin

PART #	SHEAVE	FITS ROPE	WLL
6Y-2T3	3"	5/16" - 3/8"	2T
6Y-4T4	4 1/2"	3/8" - 1/2"	4T
6Y-8T6	6"	5/8" - 3/4"	8T
6Y-8T8	8"	5/8" - 3/4"	8T



with Swivel Shackles, 30" Chain & Twist Lock™ Grab Hook

PART #	SHEAVE	FITS ROPE	WLL
6I-2TSW30TL	3"	5/16" - 3/8"	2T
6I-4TSW30TL	4 1/2"	3/8" - 1/2"	4T



with Swivel Shackles, 30" Chain & Grab Hook

PART #	SHEAVE	FITS ROPE	WLL
6I-2TSW30	3"	5/16" - 3/8"	2T
6I-4TSW30	4 1/2"	3/8" - 1/2"	4T



YOKE

Alloy Snatch Blocks

with Hook & Bronze Bushed Bearing

PART #	SHEAVE	FITS ROPE	WLL
6Y-12T6A	6"	3/4" - 7/8"	12 T
6Y-12T8A	8"	3/4" - 7/8"	12 T
6Y-12T10A	10"	3/4" - 7/8"	12 T

ONLY
44 lb



SKOOKUM

Alloy Snatch Blocks

with Composite Sheave

PART #	SHEAVE	FITS ROPE	WLL
6K-15T10A	10"	3/4" - 7/8"	15 T

ONLY
52 lb



SKOOKUM

Alloy Snatch Blocks

with Alloy Sheave

PART #	SHEAVE	FITS ROPE	WLL
6K-15T10AAS	10"	3/4" - 7/8"	15 T



SNATCH BLOCKS

Used to change the direction or gain a mechanical advantage over the load being moved. Snatch Blocks feature bronze bushings with grease fittings. Side plates open without coming apart.

- LIGHTWEIGHT ALL ALLOY SNATCH BLOCKS
- MEETS ALL REQUIREMENTS OF ASME B30.26
- BRONZE BUSHED WITH GREASE FITTINGS
- LATCH STANDARD ON SWIVEL HOOK STYLE
- CLOSED DIE FORGED STEEL SHEAVES
- FATIGUE RATED AND DATE CODED
- FORGED COMPONENTS 100% MAGNAFLUX INSPECTED

Manufactured from the highest quality tensile steel. Bronze bushings and grease fittings allow for ease of use and extended sheave life. 100% Magnaflux tested — standard on all Blocks. Supplied with model number, wire rope size, working load limit and usage warnings. Designed with a safety factor of 4:1. Test certifications and batch numbers for ease of traceability.



Tanker Tube

PART #	LENGTH	WT	WLL
BA-TANKERTUB	48"	45 lb	Lifting Beam 10,000 lb Tanker Tube 18,000 lb

YOKE

Alloy Swivel Bearing Hoist Hook with Latch

PART #	WLL
8-175N-02	2 T
8-175N-03	3 T
8-175N-05	5 T
8-175N-07	7 T



YOKE

Alloy Swivel Hoist Hook with Latch

PART #	WLL
8-175-03	3 T



Swivel Hoist Hook with Latch

PART #	WLL
4-3TASHL	3 T
4-4TASHL	4.5 T
4-7TASHL	7 T
4-11TASHL	11 T



Swivel Bearing Hoist Self-Locking Hook

PART #	FITS ROPE	WLL
X-027N-07	1/4" - 5/16"	2.5 T
X-027N-10	3/8"	4 T
X-027N-13	1/2"	6.7 T
X-027N-16	5/8"	10 T
X-027N-20	3/4"	16 T



Replacement Latch Kits

PART #	FITS ALLOY HOOKS	FITS CARBON HOOKS
4-2TL	3 T	2 T
4-3TL	4.5 T	3 T
4-5TL	7 T	5 T
4-11TL	11 T	7 T



Cable Tensioners & Guides

PART #	SIZE	WIRE ROPE
17-2N	11"	1/4" - 1/2"
17-1N	9"	1/4" - 1/2"
17-1BN	6 1/2"	1/4" - 1/2"
17-1AN	6 1/2"	1/4" - 1/2"



17-2N



17-1N



17-1BN



17-1AN

TOWING TRUCK ACCESSORIES

<i>Skates</i>	63
<i>Vehicle Positioning</i>	65
<i>Motorcycle</i>	66
<i>Dollies</i>	67
<i>Safety</i>	71
<i>Tools & Accessories</i>	72
<i>Storage</i>	73



B/A Individual Tire Skates

The rope or wire handles on all products are for handling only and are not designed to be used as an attachment or pulling point.

PART #	SIZE
48-2	3 1/2" x 15 3/4"



Individual Tire Skates

The rope or wire handles on all products are for handling only and are not designed to be used as an attachment or pulling point.

PART #	SIZE
48-100	3 1/2" x 15 3/4"



Car Carrier Square Profile Starter Ramp

Perfect for low profile cars. These ramps allow you to avoid front end damage during vehicle loading and unloading. Ramps feature a 2" grooved step to fit securely under the tail of your carrier bed.

PART #	SIZE
48-CCRL	8" x 14"



Container Skate with Plug

Moving heavy objects is made easier when using Container Skates.

PART #	DESCRIPTION	SIZE
48-CPS5	Low Profile	2 3/4"
48-CPS6	Standard	5 1/2"

48-CPS5



48-CPS6

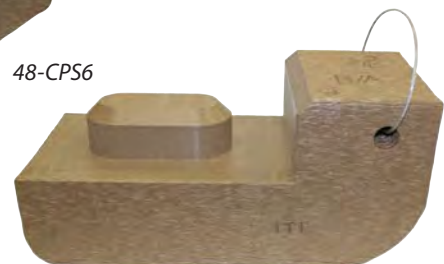

WreckMaster Interlocking Tire Skates

With interlocking teeth, these skates can be used in a variety of sizes to assist with any need. The center groove accommodates brake rotors when moving vehicles without wheels.

PART #	DESCRIPTION
48-WSN	Neon Green
48-WSB	Black



Control Arm Skate

Load vehicles with missing wheels, frozen bearings and broken ball joints, control arms or axles a snap. Both ends have a radius for easy loading and unloading without having to remove and turn the skate. Works great on trailers too!

PART #	SIZE
48-CAS4	4"
48-CAS6	6"

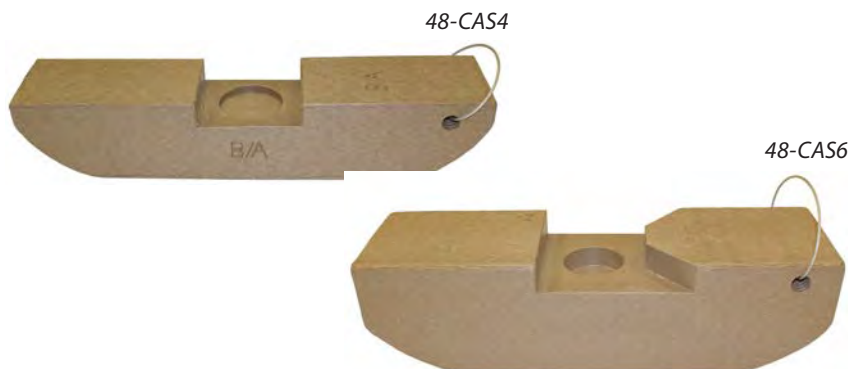

Control Arm Skate Extension

These adapters are designed to be used with the original 6" Control Arm Skate and work as an extension for larger vehicles like trucks and SUVs. They can also make loading vehicles with missing wheels, frozen bearings, broken ball joints, broken control arms, or broken axles a snap. Both ends have a radius for easy loading and unloading without having to remove and turn the skate. Works great on trailers too!



PART #	SIZE
48-6E	11 3/4" x 5 1/2" x 5 1/2"



TURTLE PLASTICS® 17" Tire Skates

PART #	DESCRIPTION	SIZE
48-TS325	Double	3 1/4"
48-TS65	Single	6 1/2"
48-TS13	Quad	13"



B/A REDiJack

B/A's ready for anything Auto Positioning Dolly makes it easy to move disabled vehicles and wrecks into position simply and easily.

- 6,400 lb Maximum Loading
- Capacity with 4 units
- 36" Maximum Tire Height
- 13" Maximum Tire Width
- Heavy Duty Castors to roll smoothly under load
- Takes less time with less effort
- Minimum of 2 REDiJacks required



PART #	DESCRIPTION	WLL
J-1	Right Hand	1,600 lb
J-1LH	Left Hand	1,600 lb



GoJak® Mounting Bracket

Mount a GoJak® to any flat surface. Holds 5000 and 6200 series GoJaks®. Easy to install and has a padlock bracket.

PART #
40-D1244



MatJack High Pressure Air Bag

PART #	SIZE	INFLATION	WLL
47-113S	15" x 15"	7 1/2"	13 T
47-122S	20" x 20"	9 1/2"	22 T
47-132S	21" x 25"	12"	32 T

GoJak® 5211

Vehicle Positioning Dolly

PART #	DESCRIPTION	MODEL
40-GJ5211	Right Hand	5211
40-GJ5211LH	Left Hand	5211
40-GJ6313	Right Hand	6313
40-GJ6313LH	Left Hand	6313



GoJak® Caster Assembly *Not Pictured

PART #	SIZE
40-GJ107	4"
40-GJ106	5"



Motorcycle Crossover Kit

B/A Products Motorcycle Cross Over Kit allows the motorcycle to be secured to a roll back or trailer by its handlebars and hand grips. Soft cups made of webbing fit over the hand grips, then nylon straps run through a central pad and to the opposite side of the motorcycle, where your tie-down straps and ratchets are attached. Tighten your tie-downs, and it's just like you are holding the bike up yourself. Kit has a Working Load Limit of 1,000 lb. * Additional tie-downs are required to secure the backside of the motorcycle to the rollback or trailer.



PART #	WLL
21-200	1,000 lb



Motorcycle Dolly

- (4) 6' Straps with Ratchets
- (1) 30" Strap with Ratchets
- (4) 16' Straps with Ratchets

Allows one person to easily & safely load and unload a bike in minutes. Disassembles to fit in a 24" tool box.

PART #	UNIT	WLL
21-5	KIT	9,000 lb



Condor® Cycle Loader

The patented locking mechanism supports the motorcycle in an upright position. Can accommodate bikes up to 2,500 lb. Straps not included.

PART #	UNIT	WLL
21-7	KIT	2,500 lb

High Pressure Single Unit Deadman Control

Hand held push button deadman control with relief to control pressurizing and deflation of high pressure air bags.

PART #	SIZE
47-201	3" x 7" x 3"



Brake Buddy Remote Braking System

PART #
BB-1





In the Ditch dollies are ergonomically designed to be balanced when carried. The spring loaded pin in the easy to operate cam-lock design self engages, locking the dolly wheels without your hand leaving the breakover bar. These dollies can be rolled to the recovery site, making them easy to use in tight spaces. High quality, well designed products.



X-Series Dolly Set

PART #	DESCRIPTION	TIRE SIZE	WLL
40-D2778	XL	4.8" x 8"	3,040 lb
40-D2778P	Zinc-Plated	4.8" x 8"	3,040 lb



X-Series SLX XD Dolly Set with Speed Lube Spindle

PART #	DESCRIPTION	TIRE SIZE	WLL
40-D2878	Regular	4.8" x 8"	3,040 lb
40-D2878-P	Zinc-Plated	4.8" x 8"	3,040 lb



Axle Rack

Fits Aluminum Telescoping Axles and Breakover Bar

PART #	DESCRIPTION
40-D1026	Single
40-D1027	Double



Universal Mounting System

This kit comes complete with everything needed to hold 2 dolly frames, 2 axles and a breakover bar. Tuff Coat Black Finish.

PART #	FITS	UNIT
40-D1162	Speed® Dolly	KIT
40-D1182	XD™ Dolly	KIT



X-Series SLX XD Dolly Set with Speed Lube Spindle

PART #	DESCRIPTION	TIRE SIZE	WLL
40-D2890	Regular	4.8" x 8"	3,040 lb
40-D2890-P	Zinc-Plated	4.8" x 8"	3,040 lb

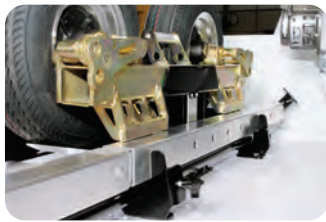

Integrated Dolly Speed® Mount

Holds one dolly frame and one telescoping axle, and breakover bar. *Fits Speed® Dolly Only.

PART #
40-D1349



W-Mount Axle Bracket

The W-Mount is ideal for those who want to mount their axles on a flat surface. Fits the Speed® Dolly and XD™ Dolly Axles and Breakover Bar. Lockable tabs for your padlock.

PART #	UNIT
40-D1242	PR



Locking Dolly Simple Mount

PART #	DESCRIPTION	FITS	SIZE
40-D1561	Regular	Speed® Dolly	9 1/2"
40-D1555	Short	Speed® Dolly	7"
40-D1564	XD™	XD™ Dolly	9"



Pro Series Aluminum Dolly Bunk

(2) Dolly Bunks (2) Retaining Chains



For mounting Dollies under your wrecker tool boxes or body. Kit includes 2 complete dolly bunks, 2 retaining chains and is lockable. Fits all sizes and brands of dollies.

PART #	UNIT
40-D1023	KIT



XL Aluminum Telescoping Dolly Axle

PART #
40-D1733



Lightweight Breakover Bar

PART #
40-D1452



Replacement Hub Assembly Kit

(2) 1" Bearings (1) 1" Seals
(4) Lug Nuts (1) Dust Cap

PART #	CAPACITY	UNIT
40-D7003	1,250 lb	KIT



1" Bearing Kit
for Dolly Wheel

PART #	UNIT
40-123	KIT



Replacement Snap Button
for Dolly Axle

PART #
40-D7008



Dust Cap
for Dolly Wheel

PART #
40-123-DC



NOT PICTURED

Steel Flange Bushing

PART #
40-D7396

Replacement Camlock Rebuild Kit

PART #
40-D7166



Replacement Load Range C Aluminum Wheel & Dolly Tire

Wheel (4 hole) with 4.80" x 8" C-Ply Carlisle Tire



PART #	SIZE	LOAD RATING
40-D7098	4:80x8	760 lb

Replacement C-Ply Steel Wheel & Dolly Tire



PART #	TIRE	DESCRIPTION	LOAD RATING
2-480x8C	4:80x8	5-Lug Wheel & Tire	760 lb
2-480x8TC	4:80x8	Tire Only	760 lb



Replacement Sealed Hub Assembly

PART #
40-D7393



Generic Dolly Strap

The classic lasso strap, but meant for use on wheel dollies. Snap hook on ratchet works great on the welded tabs on many wheel dollies.

PART #	UNIT	WLL
40-13	PR	800 lb

Sling Straps

Rubber coated 3 Ply Straps for maximum durability & flexibility. Machined holes for your mounting hardware ensure precise and easy installation.



PART #	DESCRIPTION	SIZE	WLL / PAIR
1-1	4 - Hole	10" x 47"	6,600 lb
1-4	3 - Hole	8" x 42"	5,280 lb

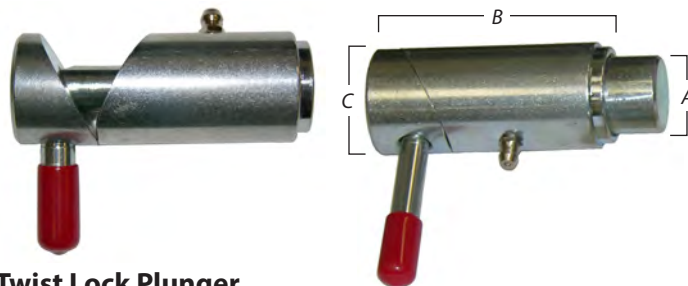

Twist Lock Plunger

Allows for one hand operation to open the assembly and put it into the automatic locking position. Used on sling arms, stabilizer legs, wheel lift forks, and more.

PART #	A	B	C
16-CL12	1/2"	2 1/2"	1"
16-CL58	5/8"	3"	1"
16-CL34	3/4"	3"	1"
16-CL1	1"	3 1/2"	1.5"



Aluminum Wheel SLX Dolly Set

PART #	SIZE	WLL
40C-SLAD4	4:80x8	3,040 lb
40C-SLAD5	5:70x8	4,280 lb



Aluminum Hub (Complete)

PART #
40C-WAHCA

5-Lug Tire on Aluminum Wheel

PART #	WLL
40C-WA4DA	760 lb



Rubber Wheel Chock

PART #	SIZE	UNIT
5-RWC1	5" x 10" x 7 1/2"	PR

Made of heavy-duty rubber. Anchored eye allows you to attach a line to keep blocks together.



Balldog Plus

B/A Exclusive! The newest innovation in hitch attachment. Pear Link fits over 1-7/8", 2" and 2-5/16" Tow Balls, Large Oblong fits into 2" and 2-1/2" Receiver Tubes.

PART #
BALldog



10 Person First Aid Kit

PART #
26-10



Fire Extinguisher with Bracket

PART #	SIZE
FE-25	2 1/2 lb
FE-5	5 lb



Sneaky Pete Door Tool *With push and pull cuts on one end, the combination of spring steel construction and narrow width bypasses lock guards.*

PART #	SIZE
12-1A	3/4" x 22"



Grizzly Bar *This long pry bar is the perfect tool to move large objects in the way during recovery or rigging situations.*

PART #	SIZE
11-GBAR	55"



Red Alert Door Tool *Rigid design for excellent leverage. Features a powder coat finish and a protective tip.*

PART #	SIZE
12-270	54"



Tarp Straps *Sold as BOX of 50*

PART #	LENGTH	PART #	LENGTH	PART #	LENGTH
38-TS15	15"	38-TS21	21"	38-TS31	31"

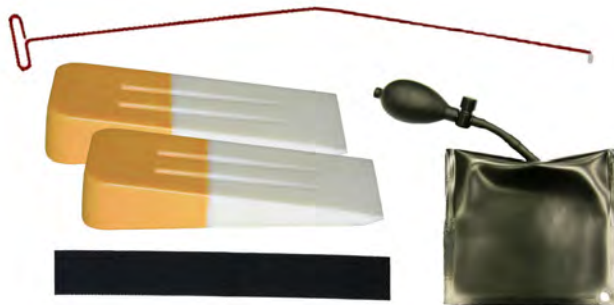

Door Tool Kit *New convenient door tool kit has all of your staple items in one package. Includes a 1"x 12" protective sleeve for ultimate protection of the the vehicle's door jamb.*

- (1) Red Alert Door Tool
- (1) Inflatable Air Wedge
- (1) Sling Strap
- (2) Plastic Window Wedge

PART #	UNIT
12-DK1	KIT

Inflatable Air Wedge

The inflatable Air Wedge carefully separates the door panel from the vehicles window, allowing easy access for long reach door tools.



PART #
12-275

Plastic Window Wedge

The rigid design separates the door panel from the vehicles window, allowing easy access for the door tools.



PART #
12-W5

SIZE
5.5" x 2.5"



PATENTED

Driveline Buddy

A convenient and hassle free tool to secure the driveline of a truck when towing.

*Includes:
Driveline Buddy
Rope Ratchet & T-Bar*

PART #
52-DLB-1



Pro Series Toolbox

Provides ample storage in a box that will fit just about anywhere. Single door handle with two rotary strikers inside of the door to keep the door closed and sealed from the weather. Comes with one oval light mounting bracket already installed, and predrilled for most ITD accessories.



PART #	SIZE
43-D1548	48" L x 18" D x 18" T
43-D1570	70" L x 18" D x 18" T



Trash Cans Sold as SET of 8

Lightweight galvanized steel trash cans with lids fit perfectly into the trash can mounts.

PART #	SIZE
44-D1086	4 Gallons
44-D1087	6 Gallons



Wrecker Trash Can Mount

Mount to any wrecker or flat surface. Made from 1/8" aluminum and has four pre-drilled mounting holes for easy installation.

PART #	DESCRIPTION	SIZE
44-D1054	Wrecker	6 Gallon
44-D1056	Carrier	6 Gallon
44-D1270	Dual	(2) 4 Gallon



Storage Fender Set

PART #	SIZE	UNIT
43-D2333	42 3/4"	PR

T-Pin with Lanyard

PART #	SIZE
TP-58	5/8" x 3"



Not Pictured

Quick Mount Toolbox Bracket

PART #	SIZE	PART #	SIZE
48-D1581	14 1/2"	48-D1588	18 1/2"
48-D1584	16 1/2"	48-D1580	20 1/2"

TOWING ELECTRIC & LIGHTING



Lights.....75
Jump Start.....77

All Wireless Truck Bars come complete with a transmitter, charge cord (allowing recharge from a 12V vehicle power outlet), instructions and a 7-Pin socket to allow the use of a cable when necessary.



TowMate

22" Wireless Magnetic Tow Light

Not iMon Compatible. This basic light features stop, tail, turn signals in a 22" lime green or yellow durable PVC housing.

PART #	TRANSMITTER
25-TM22G	Plug - In



TowMate

21" Wireless Tow Light with Side Markers

Provides stop, tail, turn and side marker lights on each end. Available with plug-in or wired-in transmitter (specify when ordering).

PART #	TRANSMITTER
25-TM21D	Plug - In



TowMate

36" Wireless 7-Way Truck Bar

Provides stop, tail, turn signals, center DOT lights and side markers. The 7-pin or 7-way is considered standard in the industry.

PART #	TRANSMITTER
25-TM36	Plug - In



TowMate

Wired Tow Lights with Side Markers

- Two stop, tail, turn lights with high-intensity LED's
- Side Marker Lights for optimal visibility
- 90 LB Pull Magnets with protective rubber boots
- 30' Arctic Cord (rated at -40°C) with 7' between lights
- 4-Pin Round Plug

PART #	UNIT
24-TB34	PAIR



Magnetic Tow Lights

The everyday workhorse lights that have been used for years. Includes a 30' Cord with 4-Way Plug, 7' of Cord between lights and magnets with covers to help prevent scratching.

PART #	DESCRIPTION	UNIT
24-1	Halogen	PAIR
24-1LED	LED	PAIR



4-Way Heavy Duty Plug & Socket

PART #	DESCRIPTION
24-3P	Plug
24-3S	Socket



12V1.3 Battery for TowMate TM2

PART # 25-BAT1



Charge Cord for TowMate TM2

PART # 25-TM2CC



Jump Start Pack

Portable & reliable 12 Volt hand held Jump Start delivers 1,700 Peak Amps & 455 Cold Cranking Amps of jump starting power.

Includes:

46" Heavy Duty, 4-Gauge Cables

Built-In Charger

PART # 41-JNC660



Plug In Jump Start Kit

This portable and reliable 12 Volt hand held jump start delivers 1,700 peak amps of jump starting power:

- 455 Cold Cranking Amps
- 46" Heavy Duty, 4-Gauge Cables
- Built-in Charger

PART # 41-3



Replacement Connector

PART # 41-700

Replacement Plug

PART # 41-700C

Power Plug Pro 30 Jump Start Kit

Includes:

30' Cables

5' Truck Harness

PART # T3-PRO30

- Tangle-Free Vutron Cable
- Fits Top & Side Post Batteries
- Protective Coated Steel Clamps
- Ergonomically Designed Handles
- Shrink Wrapped Terminals
- Heavy 4-Gauge Conductors with 100% Copper Wire
- Designed for Heavy-Duty Demands
- 500 AMP Capacity
- Built in Green Polarity Indicator Light



AUTO TRANSPORT CHAIN

*Chain Assemblies
& Hooks..... 79*

Transporting a vehicle is no small job. When you need to move a vehicle, you need to be 100-percent certain that the hardware you are using will get the job done properly and safely each and every time. If you want reliable auto transport products that you can count on for years and years, then B/A Products Co. is the best option around.

B/A
PRODUCTS CO.®

CHAIN

Chain Assemblies & Hooks

This chain's dynamic hook combination provides ultimate flexibility in the field, making it a go-to staple product.

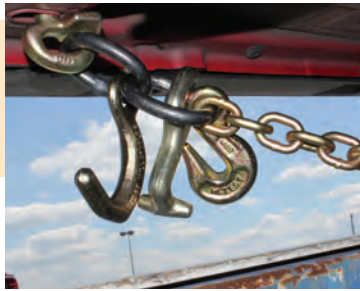

G70 Chain

with Forged Mini Datsun, Grab, R & T Hooks

PART #	SIZE	LENGTH	WLL
BA-DGRT-6	1/4"	6'	3,150 lb
BA-DGRT-8	1/4"	8'	3,150 lb
BA-DGRT-10	1/4"	10'	3,150 lb
T5-DGRT-6	5/16"	6'	4,700 lb
T5-DGRT-8	5/16"	8'	4,700 lb
T5-DGRT-10	5/16"	10'	4,700 lb



G70 Chain with Grab, R & T Hooks

PART #	SIZE	LENGTH	WLL
BA-GRT-6	1/4"	6'	3,150 lb
BA-GRT-8	1/4"	8'	3,150 lb
BA-GRT-10	1/4"	10'	3,150 lb
T5-GRT-6	5/16"	6'	4,700 lb
T5-GRT-8	5/16"	8'	4,700 lb



G70 Chain with Hammer & Grab Hooks

PART #	SIZE	LENGTH	WLL
T5-HG-8	5/16"	8'	3,150 lb



G70 Mini Datsun Grab Hook Combo

PART #	WLL
11-7MDG	3,150 lb



T & Grab Hook Combo

PART #	WLL
11-7D	4,750 lb

AUTO TRANSPORT CHAIN USE & CARE

The Working Load Limit is the maximum safe load for which the chain is designed and applies to new chain and attachments for direct, straight tension in an undamaged condition. Corrosion, wear, damage or improper loading applications reduce the safe Working Load Limit.

Chair Idler PART # BA-805



AUTO TRANSPORT STRAPS

<i>Trailer & Ratchet Straps.....</i>	82
<i>E-Track & Axle Tie-Downs.....</i>	85
<i>Ratchets & Accessories.....</i>	86

B/A

CLASSIC

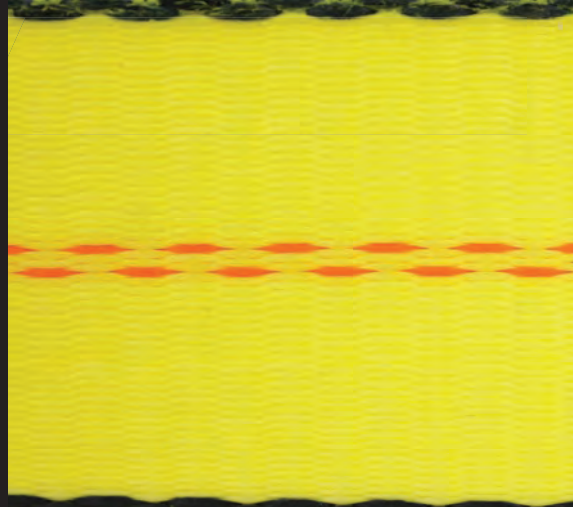

Our quality polyester Classic Webbing has been chosen as the Tower's workhorse strap for decades and has become the standard for everyday use in the towing industry.

EX

EXTREME WEAVE

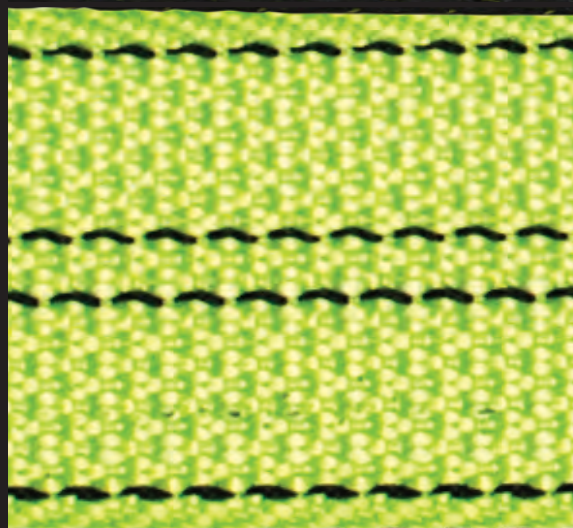

Extreme Weave, also known as 'Diamond Weave Webbing,' uses a diamond weave design to slow fraying once a strap is cut. **Warning: Once a strap is cut it should be removed from service regardless of how much it has frayed as the WLL is compromised.**

HD

HEAVY DUTY YELLOW

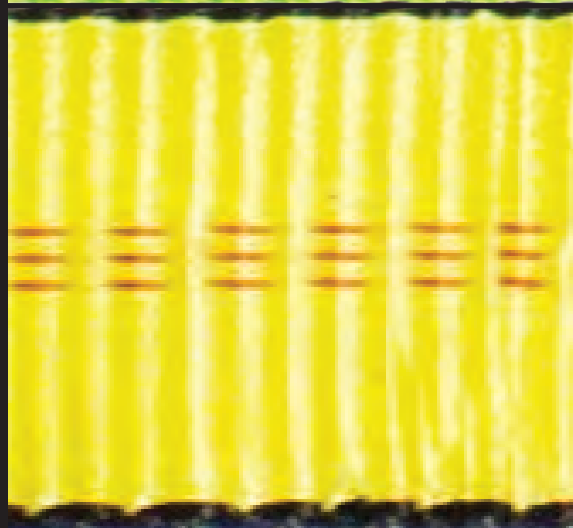

Feel the difference with the BAHD, 'Heavy Duty,' webbing with over 50% more fibers than classic web! The added benefits for this thicker, heavier design is longevity, durability and superior abrasion resistance. At 12,000 lb, this web is slightly more flexible than BAHD OEM Grade.

HD

HEAVY DUTY NATURAL OEM GRADE

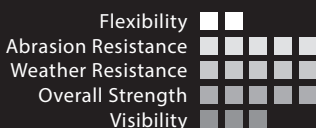

BAHD, 'Heavy Duty,' natural color webbing is B/A's strongest web at 15,000 lb., and the preferred choice by OEMs. An added friction modifier and UV protectant fortifies this web to be durable and long-lasting. Natural color resists fading.

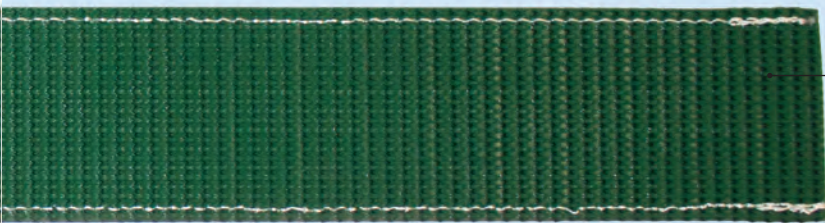

24" GRIP STRIP

for Strong Tread Grab & Low-Profile Design

The 24" Grip Strip provides durability and flexibility for use on almost every tire type. Rubber teeth give this sleeve a strong grip to prevent slippage with a **low profile design**. The new grip strip is becoming the preferred choice for auto haulers everywhere.

TRADITIONAL TIRE GRIPPERS

for Strong Tread Grab

Traditional Tire Grippers provide 3 points of contact and a strong grip for use on almost every tire type. These thick rubber blocks can withstand the wear and tear of the every day auto haul.



2" OEM Replacement Straps

with Swivel J Hooks, Tire Grippers & Protective Sleeve

PART #	LENGTH	WLL
HD NHD-3053-144	12'	3,670 lb
HD NHD-3053-168	14'	3,670 lb
HD NHD-3053-180	16'	3,670 lb

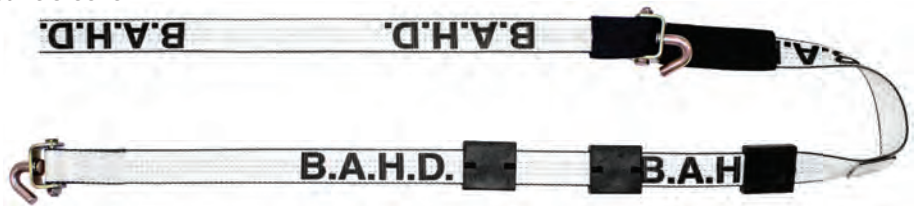

2" OEM Replacement Strap

with Swivel J Hooks, Grip Strip & Protective Sleeve

PART #	LENGTH	WLL
HD RSL-3053-144	12'	3,670 lb
HD RSL-3053-168	14'	3,670 lb



2" HD Tie-Down Strap

with Swivel J Hooks & Tire Grippers

PART #	LENGTH	WLL
HD HD-3053-120	10'	3,670 lb
HD HD-3053-144	12'	3,670 lb
HD HD-3053-168	14'	3,670 lb
HD HD-3053-180	16'	3,670 lb



2" HD Tie-Down Strap

with Swivel J Hooks & Grip Strip

PART #	LENGTH	WLL
HD HD-3144RS	12'	3,670 lb
HD HD-3168RS	14'	3,670 lb



2" Extreme Weave Tie-Down Strap

with Swivel J Hooks, Tire Grippers & Protective Sleeve

PART #	LENGTH	WLL
EX GR-C120	10'	3,670 lb
EX GR-C144	12'	3,670 lb
EX GR-C168	14'	3,670 lb
EX GR-C180	16'	3,670 lb



2" Extreme Weave Tie-Down Strap

with Swivel J Hooks, Grip Strip & Protective Sleeve

PART #	LENGTH	WLL
EX RSL-GR-C144	12'	3,670 lb
EX RSL-GR-C168	14'	3,670 lb



2" Ratchet Tie-Down Strap

with Long Swivel J Hooks & Tire Grippers

PART #	LENGTH	WLL
B/A BA-SJL120	10'	2-Point 3,670 lb 3-Point 3,670 lb



2" Ratchet Tie-Down Strap

with Swivel J Hooks & Grip Strip

PART #	LENGTH	WLL
B/A SG-SJL120	10'	2-Point 1,665 lb 3-Point 3,330 lb



2" Ratchet Tie-Down Strap

with Double Finger Hooks & Tire Grippers

PART #	LENGTH	WLL
B/A BA-R100	10'	2-Point 1,665 lb 3-Point 3,330 lb



2" Ratchet Tie-Down Strap

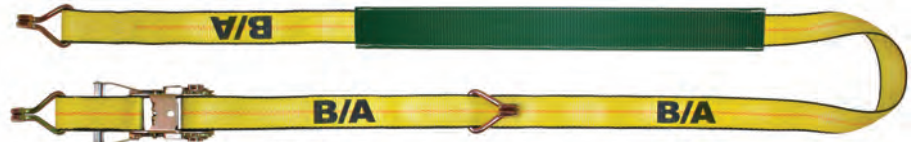

with Double Finger Hooks & Grip Strip

PART #	LENGTH	WLL
B/A SG-R100	10'	2-Point 1,665 lb 3-Point 3,330 lb



2" OEM Replacement Strap



with Double Finger Hooks & Tire Grippers

PART #	LENGTH	WLL
 NHD-DJ144	12'	3,330 lb
 NHD-DJ168	14'	3,330 lb
 NHD-DJ180	16'	3,330 lb



2" OEM Replacement Strap



with Double Finger Hooks & Grip Strip

PART #	LENGTH	WLL
 RSL-HDDJ144	12'	3,330 lb
 RSL-HDDJ168	14'	3,330 lb



2" HD Tie-Down Strap



with Double Finger Hooks & Tire Grippers

PART #	LENGTH	WLL
 HD-DJ144	12'	3,330 lb
 HD-DJ168	14'	3,330 lb



2" HD Tie-Down Strap



with Double Finger Hooks & Grip Strip

PART #	LENGTH	WLL
 HD-DJ144RS	12'	3,330 lb
 HD-DJ168RS	14'	3,330 lb



2" Extreme Weave Tie-Down Strap

with OEM Double Finger Hooks, Tire Grippers & Protective Sleeve

PART #	LENGTH	WLL
 GR-120SDJ	10'	3,330 lb
 GR-144SDJ	12'	3,330 lb
 GR-168SDJ	14'	3,330 lb



2" Extreme Weave Tie-Down Strap

with OEM Double Finger Hooks, Grip Strip & Protective Sleeve

PART #	LENGTH	WLL
 RSL-GR144SDJ	12'	3,330 lb
 RSL-GR168SDJ	14'	3,330 lb



2" Ratchet Tie-Down Strap

with O-Ring, Swivel E-Track Fittings & Tire Grippers

PART # LENGTH WLL

B/A	BA-ES100	10'	2-Point 1,665 lb
			3-Point 3,330 lb



2" Wheel Strap with D-Ring

PART # LENGTH WLL

B/A	38-1	8'	3,330 lb
------------	-------------	----	----------



2" Strap with Loop on One End

PART # LENGTH WLL

B/A	38-KT9-S	9'	3,330 lb
------------	-----------------	----	----------



1-Ply 2" Axle Strap

with Delta Rings & Protective Sleeve

PART # LENGTH WLL

B/A	38-57-20WP	20"	3,330 lb
B/A	38-57-36WP	36"	3,330 lb



Slide On Protective Sleeve

Extend the life of your straps with protection at the heaviest points of usage, shield your strap from the elements and exposure to sharp edges.

PART #	LENGTH	FITS
38-SL2	18"	2" Strap



2" Tie-Down Strap with Mini J, R & T Hooks

PART # LENGTH WLL

B/A	38-100-S	8'	4,000 lb
B/A	38-100-S10	10'	4,000 lb
B/A	38-100-S12	12'	4,000 lb



2" Through The Wheel Strap

PART #	LENGTH	WLL
B/A 38-HL9	9'	1,655 lb



2" Ratchet with Forged Swivel J Hook

PART #	HANDLE	WLL
38-20SJ1	Wide	3,670 lb



2" Ratchet with Forged Finger Hook

PART #	HANDLE	WLL
38-27	Wide	2,570 lb



2" Ratchet with Snap Hook

PART #	HANDLE	WLL
38-22D	Wide	2,000 lb

Clear Zinc



Self Colored



1/2" Bolt On D Ring

PART #	COLOR	WLL
38-DR1	Clear Zinc	4,080 lb
38-DR1	Self Colored	4,080 lb

AUTO TRANSPORT GEAR HEADS & SAFETY LOCKS

<i>Gear Heads & Pawls.....</i>	88
<i>Position Safety Locks.....</i>	89
<i>Spring Locks & Accessories.....</i>	90

Gears

PART #	ID	DESCRIPTION
BA-133L	1.33"	Left
BA-133R	1.33"	Right
BA-150L	1.5"	Left
BA-150R	1.5"	Right



Left



Right



Pawl & Pin

PART #	DESCRIPTION
BA-205	Pin
BA-P249	Pawl



Quick Release Pawl

PART #	DESCRIPTION
BA-QRL	Left
BA-QRR	Right

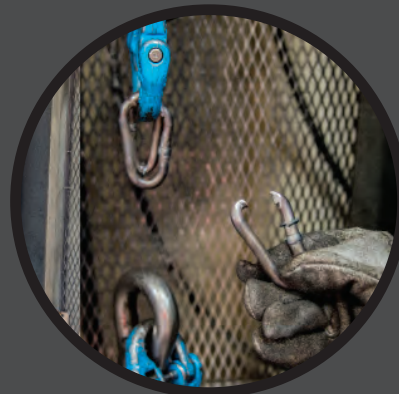

THE QUALITY YOU'VE COME TO KNOW & TRUST

B/A takes pride in meeting the highest industry standards, including but not limited to batch break testing products in our Columbia, MD facility.

LOCKS

Position Safety Locks



4" Snap Lock Pin

PART #	SIZE	DESCRIPTION
BA-58SLPW	5/8"	with Washer
BA-58SLP	5/8"	No Washer
BA-34SLPW	3/4"	with Washer



Small Safety Snap Lock Pin

PART #	SIZE
BA-DWS516275	5/16"
BA-DWS38275	3/8"



4 1/2" Pin Lock Hitch Pin

PART #	SIZE
BA-HP58N	5/8"



4" Angled Lock Pin

PART #	SIZE
BA-LP584	5/8"



5/8" Pretzel Stay Lock Pin

PART #	DESCRIPTION
BA-PP55L	Left
BA-PP55R	Right



Ratchet Hook

Easily welds on your trailer & attaches to any of our chain assemblies.

PART # BA-P26



Spring Lock with Drive Pin

PART # DESCRIPTION

SL-2 Short

SL-3 Long



Deck Key Lock

PART # SIZE

BP-34 3/4"



4" Deck Lock Pin

PART # SIZE

PP-34 3/4"



Spring Lock with Ring

PART # DESCRIPTION

BA-SL Short

BA-SL-L Long



Spring Lock with Drive Pin

PART # DESCRIPTION

SL-2P Short Pin

SL-3P Long Pin

Replacement Parts

PART # DESCRIPTION

BA-SL103 Ring

BA-SL104 Washer

BA-SL105 Drive Pin

BA-SL101S Short Pin with Ring

BA-SL102S Short Spring

BA-SL101L Long Pin with Ring

BA-SL102L Long Spring

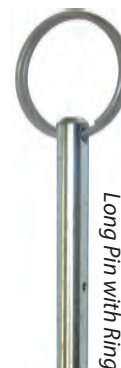
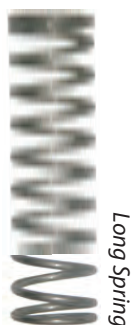

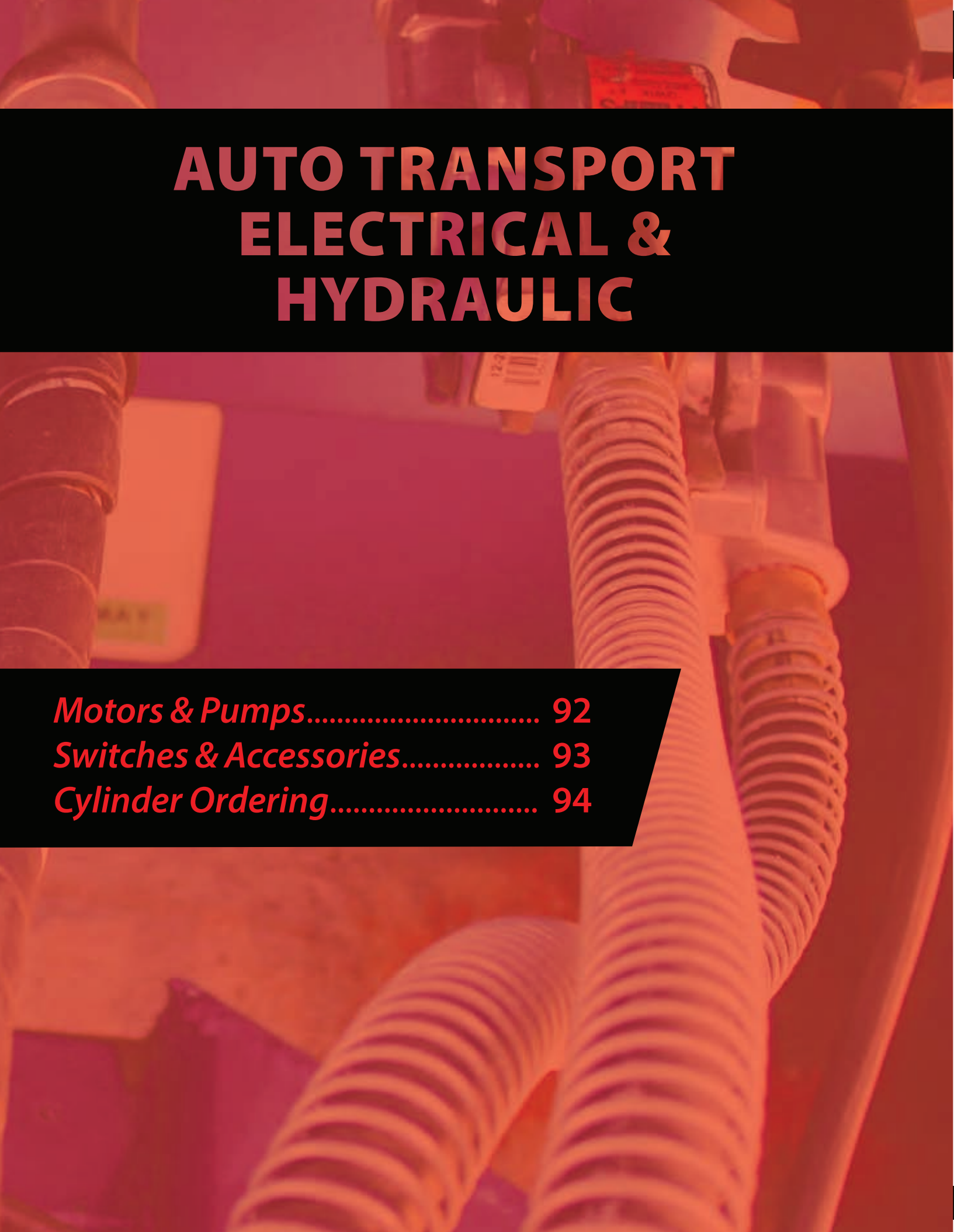

AUTO TRANSPORT ELECTRICAL & HYDRAULIC

<i>Motors & Pumps.....</i>	92
<i>Switches & Accessories.....</i>	93
<i>Cylinder Ordering.....</i>	94

12 Volt Enclosed Electric Motor
PART # EM-DD44001



Electric Motor

PART #	DESCRIPTION
EM-AL24001V	Vented
EM-AL44001V	Unvented



Hydraulic Pump
PART # HYD-PUMP1



12 / 24 Volt Solenoid

PART #	DESCRIPTION
DS-12	OEM Grade
SOL-12V	Standard



Equalizer Valve
PART # EV-122



Hydraulic Safety Double Lock Pressure Valve

PART #	SIZE
HPR-38	3/8"



12V DC Coil

PART #	SIZE
C-80034	3/8"



2-Wire Momentary Switch
PART # BA-MS2



Toggle Switch Boot Seal
PART # BA-BOOTSEAL



Push Button 2-Wire Momentary Switch
PART # BA-PBMS2

**Master Disconnect
Switch - Flaming River**
PART # FR-1044



Valve Covers

PART #	COLOR
CW-HCB	Black
CW-HCR	Red



Cylinder Bracket

PART #	SIZE
CB-078	2"

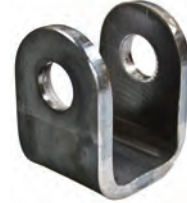

Cylinder Pin

PART #	SIZE
BA-LHCP3425	3/4" x 2 1/2"



**Cylinder Bracket
with 90° Dog Ear**

PART #	SIZE
CB-080	2"



Cylinder Pin Clip

PART # BA-RC34



24" Hydraulic Braided Hose Cutter

PART #	SIZE
HYD-C1	24"



Male



Female

**1/2" Quick
Disconnect Release Union**

PART #	TYPE
HF-050	Male
HF-051	Female



**Hydraulic Hose
Reusable Repair Unions**

For temporary repairs on the road, the repair unions allow you to load or unload and avoid costly road service repairs.

PART #	HOSE SLICE	WIRE
HYD-381W	3/8"	1
HYD-382W	3/8"	2

GUIDE TO ORDERING YOUR CYLINDERS:

Please identify the information for A, B, C and D order your cylinder.
For help on measuring & ordering your cylinders call: (410) 910-4800

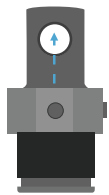
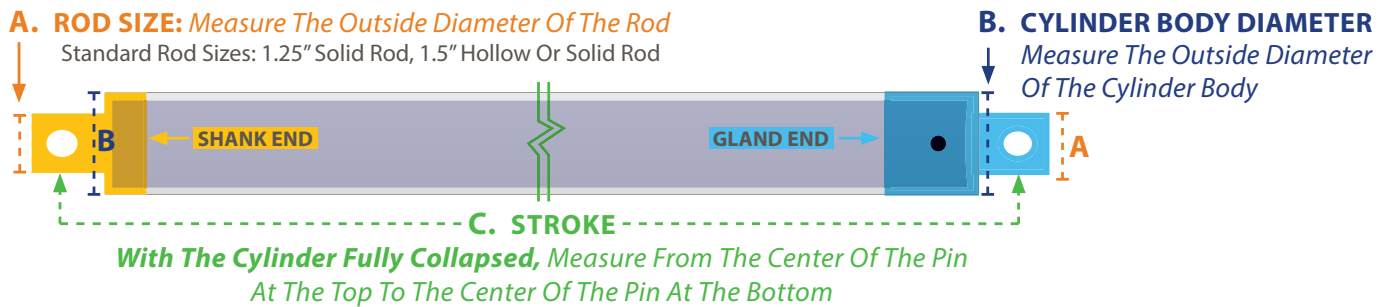

Stand Tube

Dual Port
90° or Inline

Dual Port Shank End Can Be Used As 90° Degree or Inline
Stand Tube And Telescopic Cylinders Available



FLOATING BODY CYLINDER



TELESCOPIC CYLINDER

To place an order, please visit **BAPROD.COM/ORDERS**

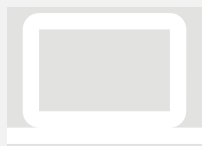

VISIT US ONLINE



COMPLETE
ORDER FORM

Order forms can be downloaded online by visiting the url above.
Call us at (800) 327-3301 with any questions.



AUTO TRANSPORT AFTERMARKET PARTS

<i>Fabricated Parts.....</i>	<i>96</i>
<i>Ramps & Accessories.....</i>	<i>97</i>



Aluminum Bat Wings

PART #	DESCRIPTION	SIZE
B-W1L	Left	Large
B-W1R	Right	Large
B-W3L	Left	Small
B-W3R	Right	Small



Aluminum Repair Pooch Panel

PART #	SIZE
DR-15120	15" x 118 1/2"
DR-1536	15" x 38 1/2"

Not Pictured

Steel Repair Panel

PART #	SIZE
DR-1539S	14 3/4" x 38 1/2"



Weld-On Flipper

PART #	DESCRIPTION	SIZE
BA-FLIPPERS5	5 Hole Steel	13 3/4"

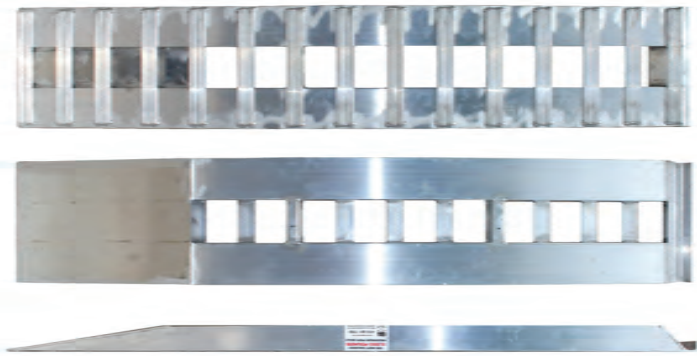

Ramp

PART #	DESCRIPTION	SIZE
R-M18096-O5	Open End	15" x 96"
R-M15094-O5T	Thin Roll	15" x 94"



Roller Style Poached Ramp

PART #	DESCRIPTION	SIZE	PER AXLE
RP-C18099R5	Universal	18" x 99"	5,000 lb
RP-B19104R5	Boydston	19" x 104"	5,000 lb

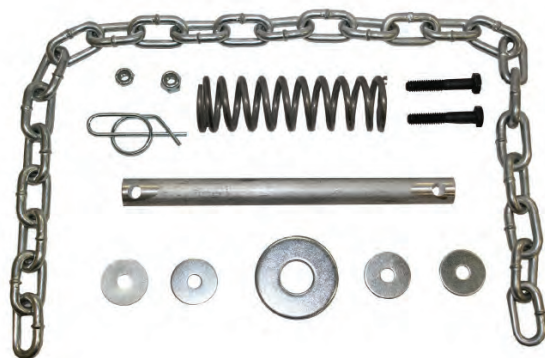

Bat Wing Hanger Kit

PART # B-W100



Ramp Roller

PART # R-R3



Skid Lock Pivot

PART #	DESCRIPTION
SLP-112L	Left Hand
SLP-112R	Right Hand

Replacement Hair Pin Clip

PART #	SIZE
BA-HPC6	3 1/4"



Anchor Pin

PART #	SIZE
BA-AP19	19"
BA-AP22	22"
BA-AP26	26"





AUTO TRANSPORT TRUCK ACCESSORIES

<i>Trailer & Ratchet Straps.....</i>	99
<i>E-Track & Axle Tie-Downs.....</i>	100
<i>Ratchets & Accessories.....</i>	101

Measuring Stick

Standard & Metric

PART #	SIZE
BA-MS15	15'
BA-MS20	20'



Measuring Stick

Standard

PART #	SIZE
BA-MS4	15'

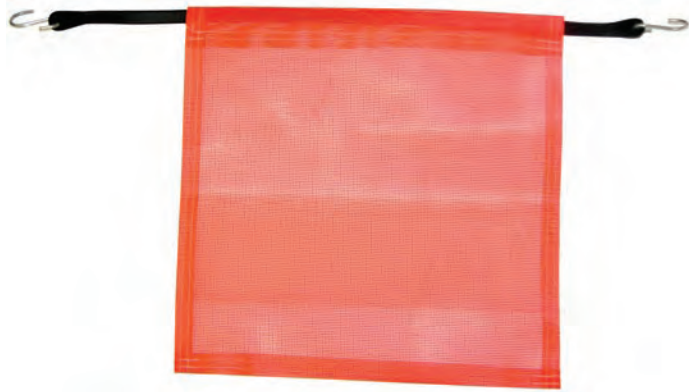
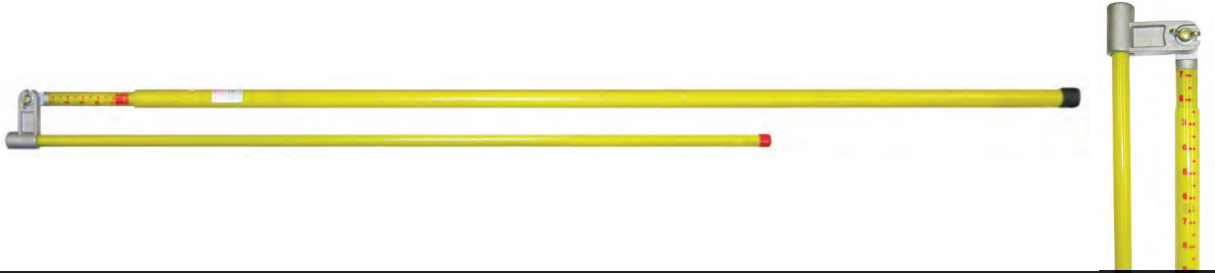

Safety Flag with Bungee Cord

PART #	DESCRIPTION	SIZE
BA-FLAG1	Orange	18" x 18"
BA-FLAGR1	Red	18" x 18"



Safety Flag with Bungee Cord & Reflective X

PART #	DESCRIPTION	SIZE
BA-FLAG2X	Orange	18" x 18"
BA-FLAG3X	Red	18" x 18"



Safety Triangle Kit

(3) Collapsible Triangles

(1) Carrying Case

PART # 26-3

Traffic Cone

with Recessed
Reflective Safety Bands

PART #	SIZE
26-TCR28	28"



Tarp Straps

Sold as BOX of 50

PART #	SIZE
38-TS15	15"
38-TS21	21"
38-TS31	31"



Winch Bar

PART #	SIZE	PART #	SIZE
WB-18	18"	WB-34	34"
WB-24	24"	WB-385	38 1/2"
WB-28	28"		



Deluxe Universal Spill Kit

- (1) Pair Goggles
- (1) Pair Gloves
- (10) 15" x 18" Absorbent Pads
- (1) Disposable Bag
- (2) 48" Absorbent Socks
- (1) 1/2 Gallon Super Sorbent

PART # BA-SPILL

Slip Plate

PART #	DESCRIPTION
SP-33005	(6) Quarts
SP-33015	(4) Gallons
SP-33203	(12) Aerosol Cans



Chain Gang Lubricant

PART #	SIZE
BA-LUBE	16 oz Can

NO-SKID®

Added Grit For Better Grip
Water-based acrylic no-skid coating will help reduce the risk of slipping or falling in a potentially slippery area. Brush or roll on any surface where sure footing is required; Car hauler decks, roll back decks, truck bodies, even floors. We also stock specially designed roller pads for proper application, Part # BA-ROLLER.
Sold in Cases; (4) Gallons / Case.

PART #	DESCRIPTION
BA-NSB	Black
BA-NSG	Grey



Brush for Lubricants

PART #	SIZE
BA-BRUSH2	2"



Sneaky Pete Door Tool

With push and pull cuts on one end, the combination of spring steel construction and narrow width bypasses lock guards.

PART #	SIZE
12-1A	3/4" x 22"



Red & White Conspicuity Tape

PART #	SIZE
36-CT150	150' Roll



Red Alert Door Tool Rigid design for excellent leverage. Features a powder coat finish and a protective tip.

PART #	SIZE
12-270	54"



Tarp Straps Sold as BOX of 50

PART #	LENGTH	PART #	LENGTH	PART #	LENGTH
38-TS15	15"	38-TS21	21"	38-TS15	15"

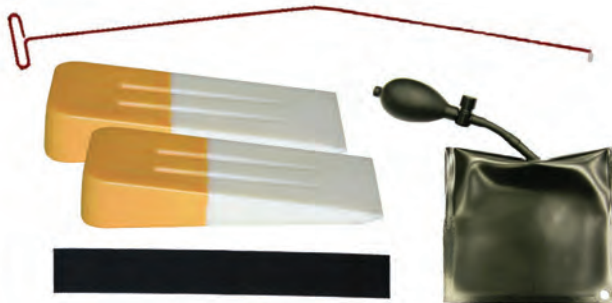

Door Tool Kit

- (1) Red Alert Door Tool
- (1) Inflatable Air Wedge
- (1) Sling Strap
- (2) Plastic Window Wedge

New convenient door tool kit has all of your staple items in one package. Includes a 1" x 12" protective sleeve for ultimate protection of the vehicle's door jamb.

PART #	UNIT
12-DK1	KIT

Inflatable Air Wedge
The inflatable Air Wedge carefully separates the door panel from the vehicles window, allowing easy access for long reach door



PART #
12-275



Plastic Window Wedge

The rigid design separates the door panel from the vehicles window, allowing easy access for the door tools.

PART #	SIZE
12-W5	5.5" x 2.5"

FIRE RESCUE



B/A
PRODUCTS CO.®

Fire & Rescue is serious business. In this industry, there are countless situations in which people's lives depend on you being able to get them out quickly and safely. In order to get a better handle on the situation, you need to make sure that you have hardware that you know will not let you down at a crucial moment. B/A Products Co. is here to provide you with exactly that with our growing line of reliable fire rescue products.

**B/A EXCLUSIVE
Twist Lock™ Shackle**

PART #	SIZE	WLL
11-TLS34	3/4"	7T
11-TLS1	1"	12.5T
11-TLS125	1 1/4"	18T



Rescue Cluster
with 8" J Hook, Mini J Hook, 2 Cluster Grab Hook & Link on Pear Link

PART #	WLL
11FR-10001	4,700 lb



Rescue Cluster
with Mini J Hook, T Hook & 2 Grab Hooks on Oblong Link

PART #	WLL
11FR-10002	4,700 lb



Rescue Cluster
with Grab, T & Compact J Hooks on Oblong Link

PART #	WLL
11FR-10003	4,700 lb



G80 3/8" V-Chain
with 15" J Hook

PART #	LENGTH	WLL
G8-118-3	3'	Straight Pull 7,100 lb @ 60° 12,000 lb

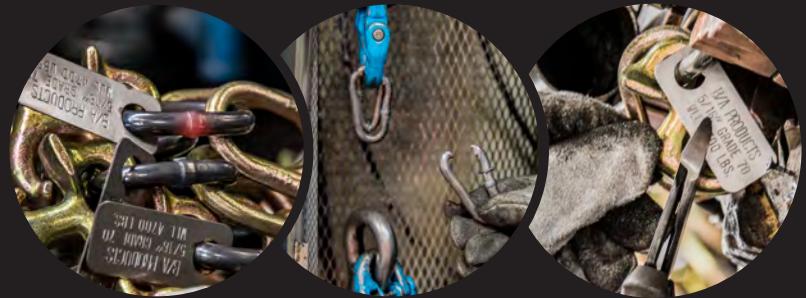

WELDED, TESTED & TAGGED

B/A takes pride in controlling the weld process in our Columbia, MD facility, batch testing, and tagging rated products. Products come tagged with a rated working load limit where applicable.

G70 Chain

with 8" J Hook & Grab Hook on One End;
2 Grab Hooks & Mini J Hook on Other End

PART #	SIZE	LENGTH	WLL
11FR-20001	5/16"	6'	4,700 lb



G70 Ultimate Axle Chain

with 8" J Hook; Grab Hooks on Other End

PART #	SIZE	LENGTH	WLL
N711-AC3	5/16"	3'	4,700 lb



G100 Chain with Twist-Lock Cradle Grab Hooks

PART #	SIZE	LENGTH	WLL
G10-3810TL	3/8"	10'	8,800 lb
G10-3820TL	3/8"	20'	8,800 lb



G100 Chain with Non-Cradle Grab Hooks

PART #	SIZE	LENGTH	WLL
G10-3810NCG	3/8"	10'	8,800 lb



G100 Chain

with Oblong Link on One End; Foundry Hook on Other End

PART #	SIZE	LENGTH	WLL
G10-12FH1	1/2"	2'	15,000 lb

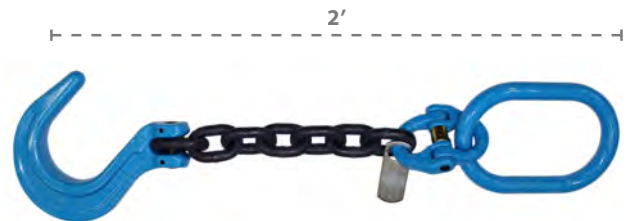

G100 Chain

with Clevis Self Locking Hook on One End;
Grab Hook & Oblong on Other End

PART #	SIZE	LENGTH	WLL
11FR-40010	3/8"	20'	8,800 lb

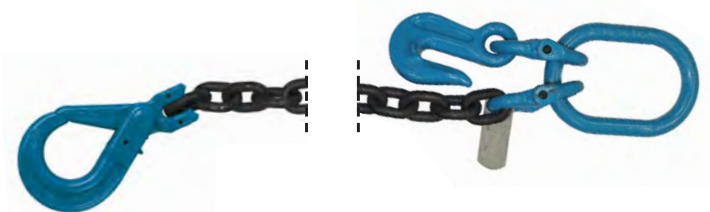

7 Piece Shackle Kit

- (2) 1" Twist Lock™ Shackles
- (2) 3/4" Alloy Screw Pin Anchor Shackles
- (2) 7/8" Alloy Screw Pin Anchor Shackles
- (1) 7/8" Grade 100 Oblong

PART #	UNIT
11FR-SKIT7	KIT



5" Red Round Sling

PART #	LENGTH
38-RSR-6	6'
38-RSR-8	8'
38-RSR-10	10'
38-RSR-12	12'

WORKING LOAD LIMIT		
VERTICAL	CHOKER	BASKET
13,200 lb	10,600 lb	26,400 lb



7" Blue Round Sling

PART #	LENGTH
38-RSB-6	6'
38-RSB-8	8'
38-RSB-10	10'
38-RSB-12	12'
38-RSB-16	16'
38-RSB-20	20'

WORKING LOAD LIMIT		
VERTICAL	CHOKER	BASKET
21,200 lb	17,000 lb	42,400 lb



10" Orange Round Sling

PART #	LENGTH
38-ENR10-5	5'
38-ENR10-8	8'
38-ENR10-10	10'
38-ENR10-12	12'
38-ENR10-16	16'
38-ENR10-20	20'

WORKING LOAD LIMIT		
VERTICAL	CHOKER	BASKET
40,000 lb	32,000 lb	80,000 lb

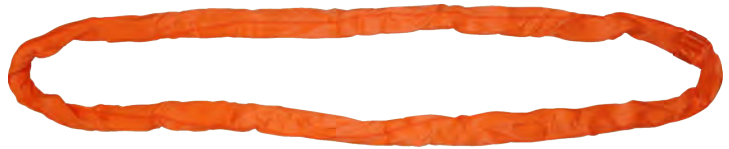

BENEFITS OF SYNTHETIC ROPE

High strength, abrasion resistant, low stretch, super tough/high wear, flexible, more torque/layer, low recoil

SAFETY

Should the Synthetic Rope break, the energy released is much less than Steel Cable because it's lighter and softer

LIGHTWEIGHT

Weighs 1/7th of Steel Cable, making it much easier to use and handle, especially where extensions may be needed.

FLOATS ON WATER 
For those that do a lot of water recoveries, this property has a profound impact on safety and ease of use

SIZE COLOR CODED

We have created each size of Synthetic Rope with its own color, making it easy to identify size and WLL

SAFER ON HANDS

The Synthetic Rope is smooth with no burrs, reducing the change of cuts and injuries during usage

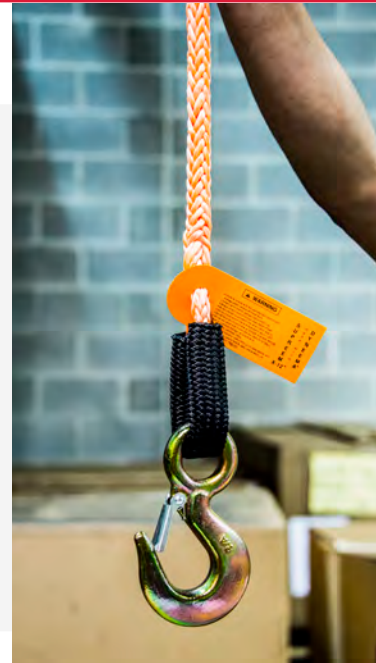

Winch Lines with Self Locking Hook

PART #	SIZE	LENGTH	WLL
● 4-R716100L	7/16"	100'	5,200 lb



Extensions with Self Locking Hook

PART #	SIZE	LENGTH	WLL
● 4-RE38100L	3/8"	100'	4,100 lb

Snatch Block

with Latched Swivel Hooks

PART #	SHEAVE	FITS ROPE	WLL
6I-2T3	3"	5/16" - 3/8"	2T
6I-4T4	4 1/2"	3/8" - 1/2"	4T

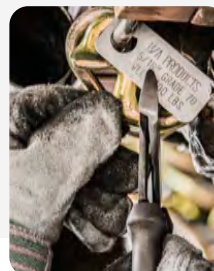

Did you know?

B/A controls many processes in-house at our Columbia, MD facility from welding our assemblies, sewing our straps, swaging our wire rope to weaving our synthetic rope!

Every rated product is batch tested and tagged with the working load limit where applicable.



SPECIFICATIONS & USAGE

WORK LOAD LIMIT

What it is & Why it is Important



NEVER EXCEED THE WORK LOAD LIMIT (WLL)

It is the **SAFE WORKING LOAD** that should be applied to a given piece of equipment, be it chain, web or wire rope. It is a portion of the nominal strength of the chain, web or wire rope, usually expressed as a ratio or percentage. Some manufacturers use the term "RATED CAPACITY."

Sometimes you will see products marked "capacity" or "maximum capacity". This is not necessarily the Work Load Limit and you should get clarification before using the product. B/A Products Co. always uses WLL, which is the most essential, precise piece of information.



IMPORTANT TERMS:

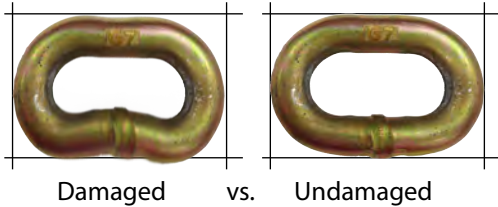

Damaged vs. Undamaged

DEFORMATION - CHAIN

The permanent distortion of materials under applied stress after overload or other misuse.

OVERHEAD LIFTING - CHAIN

That process of lifting that would elevate a freely suspended load to such a position that dropping the load would present a possibility of bodily injury or property damage. *Per NACM Standards.*

Chain Design Factors:

Grade	Trade Name	WLL
30	Proof Coil	4:1
40	High Test	3:1
70	Transport	4:1
80	Alloy	4:1
100	Grade 100 Alloy	4:1
120	Grade 120 Alloy	4:1

Proof coil and high test are designed as light duty chain, Transport is designed for tie-downs, and Alloy for overhead lifting. These ratings are set by the National Association of Chain Manufacturers (NACM).

WORKING LOAD LIMIT (WLL) - CHAIN

The "Working Load Limit" (rated capacity) is the maximum load that shall be applied in direct tension to an undamaged straight length of chain. *Per NACM Standards.*

PROOF TEST - CHAIN

The "Proof Test" (manufacturing test force) is a term designating the minimum tensile force which has been applied to a chain under a constantly increasing force in direct tension during the manufacturing process. These loads are manufacturing integrity tests and **shall not** be used as criteria for service or design purposes. *Per NACM Standards.*

MINIMUM BREAKING FORCE - CHAIN

The "Minimum Breaking Force" is the minimum force at which the chain during manufacture has been found by testing to break when a constantly increasing force is applied in direct tension. Breaking force values are not guarantees that all chain segments will endure these loads. This test is a manufacturer's attribute acceptance test and shall not be used as criterion for service or design purposes. *Per NACM Standards.*

WORKING LOAD LIMIT (WLL) - WIRE ROPE

B/A Products uses a 3.55 to 1 ratio for winch lines, per SAE Specification: B30.5. These ratings are set by ANSI/ASME, OSHA, The Wire Rope Technical Board and AWRP. *OSHA calls out that wire rope used for overhead lifting be rated at 5:1.

WORKING LOAD LIMIT (WLL) - WEB STRAPS

Web straps will either be a 3:1 when used as a tie down, or a 5:1 when used as a sling. Check the tag to determine your straps' rating. These ratings are set by The Web Sling Tie Down Association.

FOR FURTHER REFERENCE MATERIALS, PLEASE VISIT:

Wire Rope Technical Board www.domesticwirerope.org
National Association of Chain Manufacturers www.nacm.info
Web Sling Tie Down Association www.wstda.com
Associated Wire Rope Fabricators www.awrf.org

**Please see product pages for specific Work Load Limits (WLL).*



IMPORTANT INFORMATION FOR CHAIN USERS

B/A Products Co., as a manufacturer of chain assemblies, can only control the specifications of our chain products in accordance with industry and governmental standards. It would be impossible for any warning to contain all of the possible misapplications associated with the use of our products. Our warnings are intended to identify only those risks which are most common. The responsibility and understanding of the proper safe use and application of the products in our catalog, ultimately rest with the end user. Failure of the product can occur due to misapplication, abuse, intentional alteration or improper maintenance. Product failure can result in property damage, personal injury or death.

Working Load Limit (WLL): The maximum load that shall be applied in direct tension to an undamaged straight length of chain, webbing, rope or fittings.

Chain Doesn't "Just Break"



Once welded, the chain is proof-tested to the industry standard. Proof testing is the procedure whereby each link is tested to twice its Working Load Limit (WLL). By definition, the WLL is the maximum load the chain is warranted to handle.

PROOF TESTING

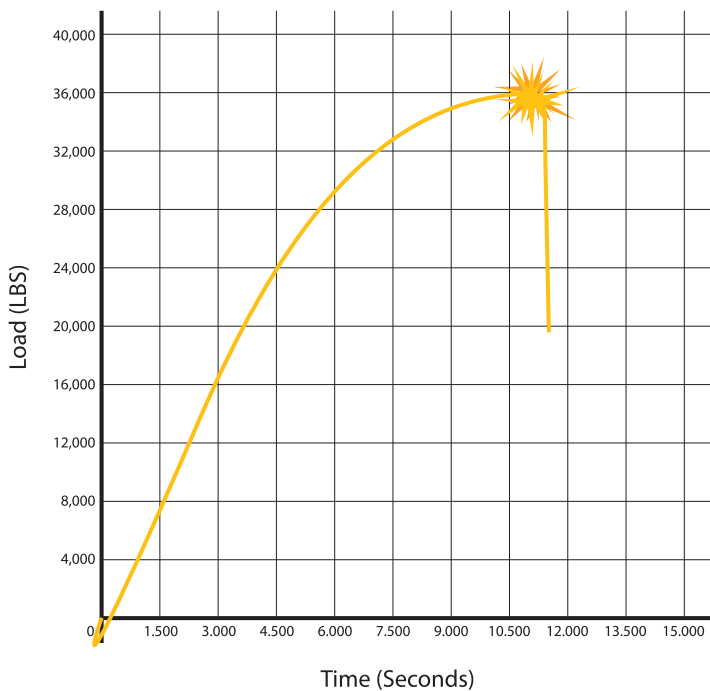

- All Working Load Limits (WLL) shown in this catalog apply only to new or "in as new" condition products.

- USE ONLY GRADE 80, 100 or 120 Chain and Attachments for overhead lifting.

- B/A Products Co. chain products are intended to be used at or below the Working Load Limits (WLL) specified in constantly increasing force applications under direct tension or in a straight line pull.

- Shock loading is prohibited and side loading must be avoided as it exerts additional dynamic forces or loading which the product is not designed to accommodate.

- The conditions involving use in certain environmental situations such as unusual (high or low) temperature, chemicals, etc., can cause changes in chain performance.

- Consult B/A Products for additional information or questions regarding the use and application of the products covered in this catalog.

The Working Load Limits and the associated safety factor of our products may be affected by wear, misuse, overloading, corrosion, deformation, intentional alteration and other use conditions. Regular inspection must be conducted to determine whether use can be continued at the assigned Working Load Limit, a reduced Working Load Limit or whether the product must be withdrawn from service. The term "Working Load Limit" contains no implication of what load the product will withstand if the product is abused and/ or misused. B/A Products Co. accepts no liability for such abuse or misuse.

THE USE OF CHAIN IS SUBJECT TO CERTAIN HAZARDS THAT CANNOT BE MET BY MECHANICAL MEANS, BUT ONLY BY THE EXERCISE OF INTELLIGENCE, CARE AND COMMON SENSE.

Please visit www.nacm.info for added specifications & warnings.

IMPORTANT INFORMATION ABOUT OUR WEBBING

Unless specified differently, all B/A Products Co. web products are made with polyester web. Polyester web stretches less than nylon and is denser than nylon, allowing a polyester strap to be thinner than a nylon strap of the same Work Load Limit. Polyester also has better moisture and acid resistance. Polyester should never be used where alkalis are present.



GENERAL WEB USAGE

All assemblies sewn by B/A Products Co. have a tag which identifies the material and the Work Load Limit of the assembly.

Tie-down assemblies have a 3 to 1 design factor, sling assemblies have a 5 to 1 design factor. See catalog pages for Work Load Limits of specific products.

When not in use, web assemblies should be stored in a cool, dry, dark place. Web assemblies should be cleaned with plain water only, and never machine washed.

REMOVAL FROM SERVICE CRITERIA

Tie-Down Assemblies and Slings shall be removed from service if any of the following conditions are observed:

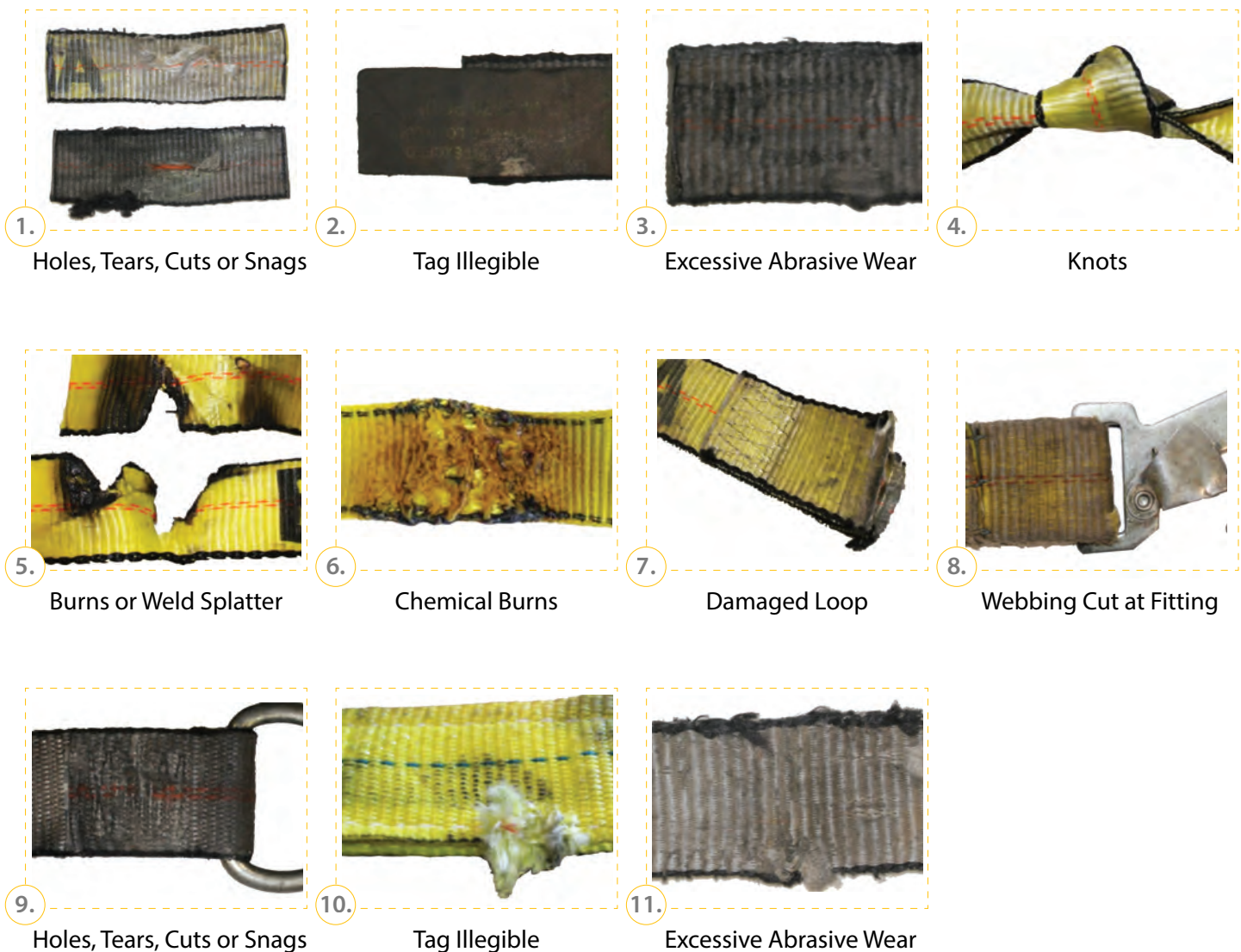

COMMON WEB FAILURES

THE MOST COMMON WEB FAILURES CONSIST OF BEING CUT AND BEING OVERLOADED

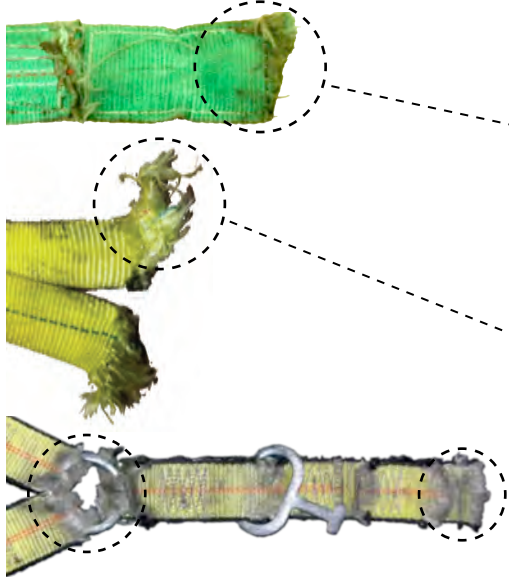

CUTS

Even what seems like a smooth edge can cut through webbing when the web is under tension and the vibration of a vehicle going down the road is introduced. Signs of being cut are that all, or most, of the web fibers are the same length with minor fraying.

OVERLOADS

This strap was overloaded. The fibers have frayed more and the ends are not in a straight line.

ABRASION

This strap shows signs of abrasion, most likely by being dragged on the ground. It is unlikely this strap would support its rated Work Load Limit.

NEVER

Tie-Downs:

- Exceed the Work Load Limit of the tie-down.
- Shock load a tie-down.
- Use tie downs to lift, lower or suspend cargo.
- Tie knots in tie-downs for any reason.
- Use web in temperatures over 194° F or under -40° F, or allow web to come into contact with objects above or below these temperatures.
- Pull tie-downs from under cargo or drop and/or drag tie-downs on any abrasive surface.

Slings:

- Exceed the Work Load Limit of the sling.
- Shock load a sling.
- Use a lifting sling that has been previously used to tow or pull cargo, for lifting. Such slings should be marked "for towing only."
- Tie knots in slings.
- Pull slings from under cargo or drag slings on abrasive surfaces.
- Use web in temperatures over 194° F or under -40° F, or allow web to come into contact with objects above or below these temperatures.

ALWAYS

Tie-Downs:

- Protect the web from corners, edges, abrasive surfaces and protrusions with sleeves or padding designed to protect the web from being cut or abraded.
- Verify the anchor points are rated equal to or greater than the Tie-Down. If anchor points are rated lower, the Tie-Down must be derated.
- Use Tie-Downs in accordance with Federal Motor Carrier Safety Administration and Commercial Vehicle Safety Alliance procedures and practices.

Web sites: www.fmcsa.dot.gov, www.cvsa.org

• Inspect Before Each Use

Slings:

- Use accepted rigging procedures. If unsure of procedures DO NOT attempt to rig or lift until a Qualified person is present and approves the procedure.
- Load hooks of fittings in the bowl of the hook, NEVER tip load.
- Protect the sling from corners, edges, abrasive surfaces and protrusions with sleeves or padding designed to protect the web from being cut or abraded.
- Load sling eyes so they are flat in shackles or hooks.
- Know the effect of the Sling Angle on Sling Capacity.
- Consider environmental factors when selecting slings.
- Know the three hitch types.

• Inspect Before Each Use

Three Hitch Types:

- Vertical
- Choker
- Basket



IMPORTANT INFORMATION FOR WIRE ROPE USERS

The following is a basic list of things that every user of wire rope should be aware of to safely use wire rope winch lines and slings. It is intended to provide basic information and is not a complete discussion. Links to sources of more information are provided on page 111.



NEVER EXCEED THE WORK LOAD LIMIT OF A WIRE ROPE.

The Work Load Limit is based on the nominal strength of a new, unused wire rope.

DETERMINE THE WORK LOAD LIMIT OF A WIRE ROPE:

The nominal strength divided by a design factor determines the Work Load Limit of a Wire Rope. The design factor will vary depending on the intended use of the wire rope and machine or equipment it is installed on. Design Factors have been established by OSHA, ANSI, ASME, SAE and other governmental and industrial organizations.

$$\frac{\text{NOMINAL STRENGTH}}{\text{DESIGN FACTOR}} = \text{WORK LOAD LIMIT}$$

No wire rope should ever be installed or used without full knowledge and consideration of the Work Load Limit. You must determine if the Work Load Limit is suitable for your use.

B/A Products Co. uses a design factor of 3.55 to 1, per ANSI/ASME 13.30.5 for winch lines.

WIRE ROPE WEARS OUT.

The strength of a wire rope decreases with each use.



WIRE ROPE WILL FAIL IF IT IS:

- WORN OUT
- OVERLOADED
- MISUSED
- DAMAGED
- IMPROPERLY MAINTAINED

Worn or improperly sized sheaves, broken wires, kinks, corrosion, excessive heat and lack of lubrication are some of the factors that can reduce wire rope strength.

NEVER OVERLOAD A WIRE ROPE.

Any load greater than the Work Load Limit is an overload (it is so important we said it twice). never shock load a wire rope.

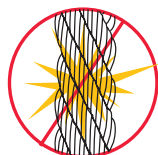

Never allow a wire rope to contact electric wires or conduct electric current.

Most wire rope installations require periodic inspection and record keeping of inspections by a qualified person. The purpose of the inspections is to determine if the wire rope is suitable for safe use in its intended purpose. Inspection criteria and removal from service criteria have been established by OSHA, ANSI, ASME and similar organizations. In addition, the inspection should include the condition of the sheaves, drums and any other equipment the wire rope comes in contact with.

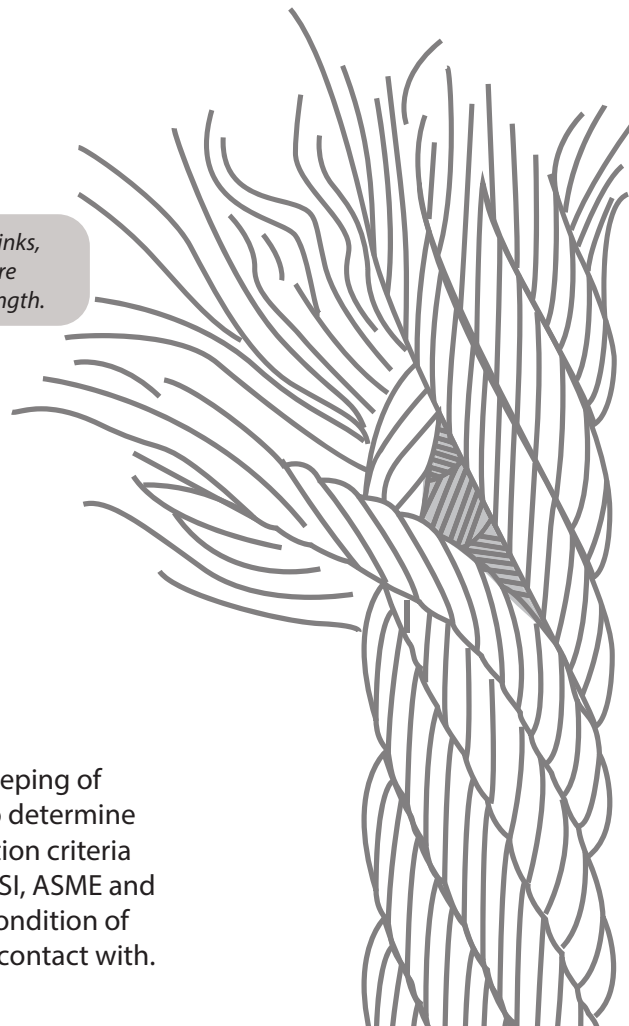

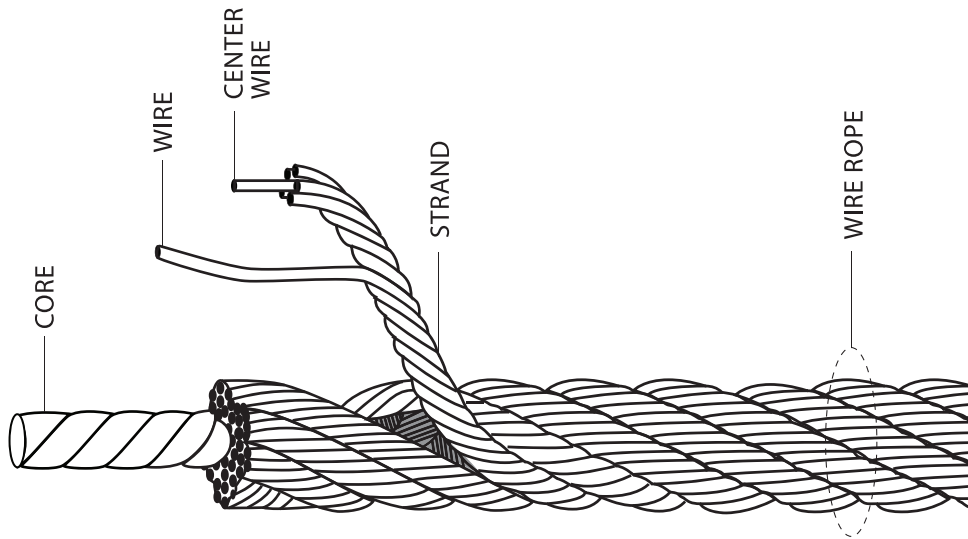

PARTS OF THE WIRE ROPE

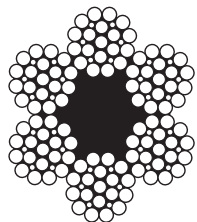

6 x 25 EIPS
FC
6 Strands
Finish
Flexibility

Extra Improved Plow Steel
 Fiber Core
 19-25 individual wires per strand
 Bright (Plain Steel) with light oil lube

■ ■ ■ ■ ■

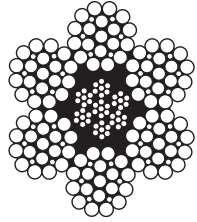

6 x 25 EIPS
IWRC
6 Strands
Finish
Flexibility

Extra Improved Plow Steel
 Independent Wire Rope Center
 19-25 individual wires per strand
 Bright (Plain Steel) with light oil lube

■ ■ ■ ■ ■

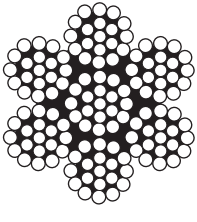

7 x 19 EIPS
IWRC
7 Strands
Finish
Flexibility

Galvanized Aircraft Cable
 Independent Wire Rope Center
 19 individual wires per strand
 Galvanized for corrosion protection

■ ■ ■

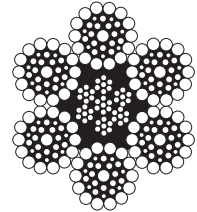

6 x 37 EIPS
IWRC
6 Strands
Finish
Flexibility

Extra Improved Plow Steel
 Independent Wire Rope Center
 6 strands of 37 individual wires
 Bright (Plain Steel) with light oil lube

■ ■ ■ ■ ■

All Wire Rope used by B/A Products Co. is Right Regular Lay. All Assemblies are Swaged in Hydraulic Presses with Steel Sleeves. All Hooks are sized so the hook Work Load is equal to or greater than the Work Load of the Wire Rope. Please see catalog page for Work Load Limits of specific Winch Lines.

NEVER EXCEED THE WORK LOAD LIMIT.

HOW TO MEASURE WIRE ROPE DIAMETER

Wire rope diameter is measured at the outermost diameter of the strands.

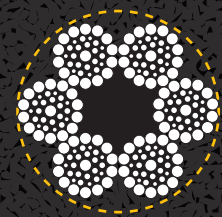

DESIRED MEASUREMENT

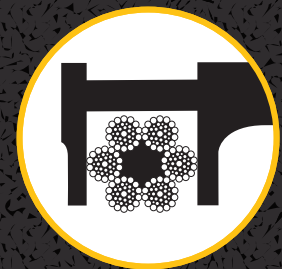

CORRECT WAY TO MEASURE WITH CALIPERS

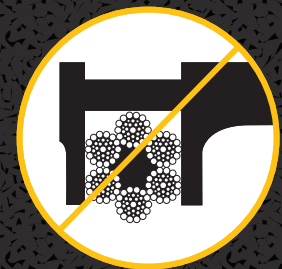

INCORRECT WAY TO MEASURE WITH CALIPERS

FOR MORE INFORMATION

The Wire Rope Technical Board
www.wirropetechnicalboard.org

Associated Wire Rope Fabricators
 (AWRF) www.awrf.org

OSHA
www.osha.gov

ASME
www.asme.org

BAPROD.COM/SPECS-USAGE



Follow B/A online to learn more about our safety processes

B/A DISTRIBUTORS

For over forty years, B/A has developed a strong network of distributors all over the world and primarily made up of small, family-owned businesses. To locate and support your local distributor, please visit baproduct.com and navigate to the distributor map.

WARRANTY INFORMATION

B/A PRODUCTS CO. WARRANTS THAT its products shall be free from defects in quality for a period of ninety (90) days from date of shipment. B/A Products Co. sole liability and customer remedy is limited to the replacement of any products determined by B/A Products Co. to be defective in quality; providing that claims for any defects are made within the warranty period.

THE WARRANTY PROVISIONS CONTAINED in this statement are expressly in lieu of all other warranties; express, statutory or implied in fact or by law. There are no implied warranties of merchantability or fitness for a particular purpose made in connection with the sale of products. The warranty provisions shall not apply to defects resulting from improper or unspecified uses or applications.

SOLE LIABILITY FOR BREACH OF WARRANTY shall be limited to the replacement of the products as provided above and the customer waives all other remedies. B/A Products Co. shall not be liable for loss of profits loss of use, damages or injury to persons, or any other consequential damages of any kind, nor shall B/A Products Co. be liable for any costs of replacement incurred by customer in the absence of specific written authorization from B/A Products Co. to make such a replacement.

WE RESERVE THE RIGHT TO CHANGE product design, material, specifications, packing, finish, policies, conditions, etc. without incurring obligation. All orders are subject to current prices at time of shipment.

Please Call: (800) 327-3301 if you have any questions or concerns.

B/A PRODUCTS CO.®

HUMBLE BEGINNINGS

B/A's founder, Mel Berman began by hand making parts in his Hollywood, FL garage. He later created and patented the original '8-point tie-down,' to solve problems expressed by towers of vehicles shifting in transit. The 8-point tie-down system went on to become a standard throughout the industry. Mel was inducted into the International Towing and Recovery Museum's hall of fame in 2015 for his contribution to further safety in the towing and recovery industry. Mel & Enid Berman, Founders of B/A Products Co. pictured left.



Experience Makes the Difference.

B/A sponsors and assists in multiple training sessions throughout the year to drive the importance of continuing education. A properly trained operator is a safe operator. Many B/A employees have been at the controls themselves and can offer some insight or understanding to issues you might be facing. Just give us a call!



(800) 327-3301 www.baprod.com